

R&S®FSH4/8/13/20 Spectrum Analyzer Quick Start Guide



1309.6269.12 – 08

The Quick Start Guide describes the following R&S®FSH models and options:

- R&S FSH4 (1309.6000.04)
 - R&S FSH4 (1309.6000.14)
 - R&S FSH4 (1309.6000.24)
 - R&S FSH8 (1309.6000.08)
 - R&S FSH8 (1309.6000.18)
 - R&S FSH8 (1309.6000.28)
 - R&S FSH13 (1314.2000.13)
 - R&S FSH20 (1314.2000.20)
 - R&S FSH4 (1309.6000.54, equivalent to 1309.6000.04)
 - R&S FSH4 (1309.6000.64, equivalent to 1309.6000.14)
 - R&S FSH4 (1309.6000.74, equivalent to 1309.6000.24)
 - R&S FSH8 (1309.6000.58, equivalent to 1309.6000.08)
 - R&S FSH8 (1309.6000.68, equivalent to 1309.6000.18)
 - R&S FSH8 (1309.6000.78, equivalent to 1309.6000.28)
 - R&S FSH13 (1314.2000.63, equivalent to 1314.2000.13)
 - R&S FSH20 (1314.2000.70, equivalent to 1314.2000.20)
-
- R&S FSH-K41 (1304.5612.02)
 - R&S FSH-K42 (1309.5629.02)
 - R&S HA-Z2240 (1309.6700.02)

The contents of this manual correspond to firmware version 2.60 or higher.

© 2014 Rohde & Schwarz GmbH & Co. KG
Muehldorfstr. 15, 81671 Munich, Germany
Phone: +49 89 4129-0
Fax: +49 89 4129-12 164
E-mail: info@rohde-schwarz.com
Internet: <http://www.rohde-schwarz.com>

81671 Munich, Germany
Subject to change – Data without tolerance limits is not binding.
R&S® is a registered trademark of Rohde & Schwarz GmbH & Co. KG.
Trade names are trademarks of the owners.

The following abbreviations are used throughout this manual:
R&S®FSH4/8/13/20 are abbreviated as R&S FSH, R&S®FSH4View is abbreviated as R&S FSH4View.

Basic Safety Instructions







Always read through and comply with the following safety instructions!

All plants and locations of the Rohde & Schwarz group of companies make every effort to keep the safety standards of our products up to date and to offer our customers the highest possible degree of safety. Our products and the auxiliary equipment they require are designed, built and tested in accordance with the safety standards that apply in each case. Compliance with these standards is continuously monitored by our quality assurance system. The product described here has been designed, built and tested in accordance with the attached EC Certificate of Conformity and has left the manufacturer's plant in a condition fully complying with safety standards. To maintain this condition and to ensure safe operation, you must observe all instructions and warnings provided in this manual. If you have any questions regarding these safety instructions, the Rohde & Schwarz group of companies will be happy to answer them.

Furthermore, it is your responsibility to use the product in an appropriate manner. This product is designed for use solely in industrial and laboratory environments or, if expressly permitted, also in the field and must not be used in any way that may cause personal injury or property damage. You are responsible if the product is used for any intention other than its designated purpose or in disregard of the manufacturer's instructions. The manufacturer shall assume no responsibility for such use of the product.

The product is used for its designated purpose if it is used in accordance with its product documentation and within its performance limits (see data sheet, documentation, the following safety instructions). Using the product requires technical skills and a basic knowledge of English. It is therefore essential that only skilled and specialized staff or thoroughly trained personnel with the required skills be allowed to use the product. If personal safety gear is required for using Rohde & Schwarz products, this will be indicated at the appropriate place in the product documentation. Keep the basic safety instructions and the product documentation in a safe place and pass them on to the subsequent users.





Symbols and safety labels

						
Observe product documen-tation	Danger of electric shock	Warning! Hot surface	PE terminal	Ground	Ground terminal	Attention! Electrostatic sensitive devices

Observing the safety instructions will help prevent personal injury or damage of any kind caused by dangerous situations. Therefore, carefully read through and adhere to the following safety instructions before and when using the product. It is also absolutely essential to observe the additional safety instructions on personal safety, for example, that appear in relevant parts of the product documentation. In these safety instructions, the word "product" refers to all merchandise sold and distributed by the Rohde & Schwarz group of companies, including instruments, systems and all accessories.

Tags and their meaning

The following signal words are used in the product documentation in order to warn the reader about risks and dangers.

 DANGER	indicates a hazardous situation which, if not avoided, will result in death or serious injury.
 WARNING	indicates a hazardous situation which, if not avoided, could result in death or serious injury.
 CAUTION	indicates a hazardous situation which, if not avoided, could result in minor or moderate injury.
 NOTICE	indicates the possibility of incorrect operation which can result in damage to the product.

In the product documentation, the word ATTENTION is used synonymously.

These tags are in accordance with the standard definition for civil applications in the European Economic Area. Definitions that deviate from the standard definition may also exist in other economic areas or military applications. It is therefore essential to make sure that the tags described here are always used only in connection with the related product documentation and the related product. The use of tags in connection with unrelated products or documentation can result in misinterpretation and in personal injury or material damage.

Operating states and operating positions

The product may be operated only under the operating conditions and in the positions specified by the manufacturer. If the manufacturer's specifications are not observed, this can result in electric shock, fire and/or serious personal injury or death. Applicable local or national safety regulations and rules for the prevention of accidents must be observed in all work performed.

1. The R&S FSH is protected against dripping water and dust (IP degree 51). Unless otherwise specified, the following requirements apply to Rohde & Schwarz products: predefined operating position is always with the housing floor facing down, IP protection 2X, pollution severity 2, overvoltage category 2, use only in enclosed spaces, max. operation altitude 4600 m above sea level, max. transport altitude 12000 m above sea level. A tolerance of $\pm 10\%$ shall apply to the nominal voltage and of $\pm 5\%$ to the nominal frequency.

2. Do not place the product on heat-generating devices such as radiators or fan heaters. The ambient temperature must not exceed the maximum temperature specified in the product documentation or in the data sheet. Product overheating can cause electric shock, fire and/or serious personal injury or death.

Electrical Safety

If the information on electrical safety is not observed either at all to the extent necessary, electric shock, fire and/or serious personal injury or death may occur.

1. Prior to switching on the product, always ensure that the nominal voltage setting on the power supply matches the nominal voltage of the AC supply network.
2. If the product does not have a power switch for disconnection from the AC supply network, the plug of the connecting cable is regarded as the disconnecting device. In such cases, always ensure that the power plug is easily reachable and accessible at all times (corresponding to the length of connecting cable, approx. 2 m). Functional or electronic switches are not suitable for providing disconnection from the AC supply network. If products without power switches are integrated into racks or systems, a disconnecting device must be provided at the system level.
3. Never use the product if the power cable is damaged. Check the power cable on a regular basis to ensure that it is in proper operating condition. By taking appropriate safety measures and carefully laying the power cable, you can ensure that the cable will not be damaged and that no one can be hurt by, for example, tripping over the cable or suffering an electric shock.
4. The product may be operated only from TN/TT supply networks fused with max. 16 A (higher fuse only after consulting with the Rohde & Schwarz group of companies).
5. Do not insert the plug into sockets that are dusty or dirty. Insert the plug firmly and all the way into the socket. Otherwise, sparks that result in fire and/or injuries may occur.
6. Do not overload any sockets, extension cords or connector strips; doing so can cause fire or electric shocks.
7. For measurements in circuits with voltages $V_{\text{rms}} > 30 \text{ V}$, suitable measures (e.g. appropriate measuring equipment, fusing, current limiting, electrical separation, insulation) should be taken to avoid any hazards.
8. Ensure that the connections with information technology equipment, e.g. PCs or other industrial computers, comply with the IEC60950-1/EN60950-1 or IEC61010-1/EN 61010-1 standards that apply in each case.
9. Unless expressly permitted, never remove the cover or any part of the housing while the product is in operation. Doing so will expose circuits and components and can lead to injuries, fire or damage to the product.
10. For permanently installed equipment without built-in fuses, circuit breakers or similar protective devices, the supply circuit must be fused in such a way that anyone who has access to the product, as well as the product itself, is adequately protected from injury or damage.

11. Use suitable overvoltage protection to ensure that no overvoltage (such as that caused by a bolt of lightning) can reach the product. Otherwise, the person operating the product will be exposed to the danger of an electric shock.
12. Any object that is not designed to be placed in the openings of the housing must not be used for this purpose. Doing so can cause short circuits inside the product and/or electric shocks, fire or injuries.
13. Unless specified otherwise, products are not liquid-proof (see also section "Operating states and operating positions", item 1. Therefore, the equipment must be protected against penetration by liquids. If the necessary precautions are not taken, the user may suffer electric shock or the product itself may be damaged, which can also lead to personal injury.
14. Prior to cleaning the product, disconnect it completely from the power supply (e.g. AC supply network or battery). Use a soft, non-linting cloth to clean the product. Never use chemical cleaning agents such as alcohol, acetone or diluents for cellulose lacquers.

Operation

1. Operating the products requires special training and intense concentration. Make sure that persons who use the products are physically, mentally and emotionally fit enough to do so; otherwise, injuries or material damage may occur. It is the responsibility of the employer/operator to select suitable personnel for operating the products.
2. Before you move or transport the product, read and observe the section titled "Transport".
3. As with all industrially manufactured goods, the use of substances that induce an allergic reaction (allergens) such as nickel cannot be generally excluded. If you develop an allergic reaction (such as a skin rash, frequent sneezing, red eyes or respiratory difficulties) when using a Rohde & Schwarz product, consult a physician immediately to determine the cause and to prevent health problems or stress.
4. Before you start processing the product mechanically and/or thermally, or before you take it apart, be sure to read and pay special attention to the section titled "Waste disposal", item 1.
5. Depending on the function, certain products such as RF radio equipment can produce an elevated level of electromagnetic radiation. Considering that unborn babies require increased protection, pregnant women must be protected by appropriate measures. Persons with pacemakers may also be exposed to risks from electromagnetic radiation. The employer/operator must evaluate workplaces where there is a special risk of exposure to radiation and, if necessary, take measures to avert the potential danger.
6. Should a fire occur, the product may release hazardous substances (gases, fluids, etc.) that can cause health problems. Therefore, suitable measures must be taken, e.g. protective masks and protective clothing must be worn.

Repair and service

1. The product may be opened only by authorized, specially trained personnel. Before any work is performed on the product or before the product is opened, it must be disconnected from the AC supply network. Otherwise, personnel will be exposed to the risk of an electric shock.
2. Adjustments, replacement of parts, maintenance and repair may be performed only by electrical experts authorized by Rohde & Schwarz. Only original parts may be used for replacing parts relevant to safety (e.g. power switches, power transformers, fuses). A safety test must always be performed after parts relevant to safety have been replaced (visual inspection, PE conductor test, insulation resistance measurement, leakage current measurement, functional test). This helps ensure the continued safety of the product.

Batteries and rechargeable batteries/cells

If the information regarding batteries and rechargeable batteries/cells is not observed either at all or to the extent necessary, product users may be exposed to the risk of explosions, fire and/or serious personal injury, and, in some cases, death. Batteries and rechargeable batteries with alkaline electrolytes (e.g. lithium cells) must be handled in accordance with the EN 62133 standard.

1. Cells must not be taken apart or crushed.
2. Cells or batteries must not be exposed to heat or fire. Storage in direct sunlight must be avoided. Keep cells and batteries clean and dry. Clean soiled connectors using a dry, clean cloth.
3. Cells or batteries must not be short-circuited. Cells or batteries must not be stored in a box or in a drawer where they can short-circuit each other, or where they can be short-circuited by other conductive materials. Cells and batteries must not be removed from their original packaging until they are ready to be used.
4. Keep cells and batteries out of the hands of children. If a cell or a battery has been swallowed, seek medical aid immediately.
5. Cells and batteries must not be exposed to any mechanical shocks that are stronger than permitted.
6. If a cell develops a leak, the fluid must not be allowed to come into contact with the skin or eyes. If contact occurs, wash the affected area with plenty of water and seek medical aid.
7. Improperly replacing or charging cells or batteries that contain alkaline electrolytes (e.g. lithium cells) can cause explosions. Replace cells or batteries only with the matching Rohde & Schwarz type (see parts list) in order to ensure the safety of the product.
8. Cells and batteries must be recycled and kept separate from residual waste. Rechargeable batteries and normal batteries that contain lead, mercury or cadmium are hazardous waste. Observe the national regulations regarding waste disposal and recycling.

Transport

1. Handles on the products are designed exclusively to enable personnel to transport the product. It is therefore not permissible to use handles to fasten the product to or on transport equipment such as cranes, fork lifts, wagons, etc. The user is responsible for securely fastening the products to or on the means of transport or lifting. Observe the safety regulations of the manufacturer of the means of transport or lifting. Noncompliance can result in personal injury or material damage.
2. If you use the product in a vehicle, it is the sole responsibility of the driver to drive the vehicle safely and properly. The manufacturer assumes no responsibility for accidents or collisions. Never use the product in a moving vehicle if doing so could distract the driver of the vehicle. Adequately secure the product in the vehicle to prevent injuries or other damage in the event of an accident.

Waste disposal

1. If products or their components are mechanically and/or thermally processed in a manner that goes beyond their intended use, hazardous substances (heavy-metal dust such as lead, beryllium, nickel) may be released. For this reason, the product may only be disassembled by specially trained personnel. Improper disassembly may be hazardous to your health. National waste disposal regulations must be observed.

Informaciones Elementales de Seguridad







Es imprescindible leer y observar las siguientes instrucciones e informaciones de seguridad!

El principio del grupo de empresas Rohde & Schwarz consiste en tener nuestros productos siempre al día con los estándares de seguridad y de ofrecer a nuestros clientes el máximo grado de seguridad. Nuestros productos y todos los equipos adicionales son siempre fabricados y examinados según las normas de seguridad vigentes. Nuestro sistema de garantía de calidad controla constantemente que sean cumplidas estas normas. El presente producto ha sido fabricado y examinado según el certificado de conformidad adjunto de la UE y ha salido de nuestra planta en estado impecable según los estándares técnicos de seguridad. Para poder preservar este estado y garantizar un funcionamiento libre de peligros, el usuario deberá atenerse a todas las indicaciones, informaciones de seguridad y notas de alerta. El grupo de empresas Rohde & Schwarz está siempre a su disposición en caso de que tengan preguntas referentes a estas informaciones de seguridad.

Además queda en la responsabilidad del usuario utilizar el producto en la forma debida. Este producto está destinado exclusivamente al uso en la industria y el laboratorio o, si ha sido expresamente autorizado, para aplicaciones de campo y de ninguna manera deberá ser utilizado de modo que alguna persona/cosa pueda sufrir daño. El uso del producto fuera de sus fines definidos o sin tener en cuenta las instrucciones del fabricante queda en la responsabilidad del usuario. El fabricante no se hace en ninguna forma responsable de consecuencias a causa del mal uso del producto.





Se parte del uso correcto del producto para los fines definidos si el producto es utilizado conforme a las indicaciones de la correspondiente documentación del producto y dentro del margen de rendimiento definido (ver hoja de datos, documentación, informaciones de seguridad que siguen). El uso del producto hace necesarios conocimientos técnicos y ciertos conocimientos del idioma inglés. Por eso se debe tener en cuenta que el producto solo pueda ser operado por personal especializado o personas instruidas en profundidad con las capacidades correspondientes. Si fuera necesaria indumentaria de seguridad para el uso de productos de Rohde & Schwarz, encontraría la información debida en la documentación del producto en el capítulo correspondiente. Guarde bien las informaciones de seguridad elementales, así como la documentación del producto, y entréguelas a usuarios posteriores.

Símbolos y definiciones de seguridad

						
Ver documentación de producto	Peligro de golpe de corriente	¡Advertencia! Superficie caliente	Conexión a conductor protector	Conexión a tierra	Conexión a masa conductora	¡Cuidado! Elementos de construcción con peligro de carga electroestática

Tener en cuenta las informaciones de seguridad sirve para evitar en lo posible lesiones o daños por peligros de toda clase. Por eso es imprescindible leer detalladamente y comprender por completo las siguientes informaciones de seguridad antes de usar el producto, y respetarlas durante el uso del producto. Deberán tenerse en cuenta todas las demás informaciones de seguridad, como p. ej. Las referentes a la protección de personas, que encontrarán en el capítulo correspondiente de la documentación del producto y que también son de obligado cumplimiento. En las presentes informaciones de seguridad se recogen todos los objetos que distribuye el grupo de empresas Rohde & Schwarz bajo la denominación de "producto", entre ellos también aparatos, instalaciones así como toda clase de accesorios.

Palabras de señal y su significado

 PELIGRO	PELIGRO identifica un peligro inminente con riesgo elevado que provocará muerte o lesiones graves si no se evita.
 ADVERTENCIA	ADVERTENCIA identifica un posible peligro con riesgo medio de provocar muerte o lesiones (graves) si no se evita.
 ATENCIÓN	ATENCIÓN identifica un peligro con riesgo reducido de provocar lesiones leves o moderadas si no se evita.
 AVISO	AVISO indica la posibilidad de utilizar mal el producto y, como consecuencia, dañarlo. En la documentación del producto se emplea de forma sinónima el término CUIDADO.

Las palabras de señal corresponden a la definición habitual para aplicaciones civiles en el área económica europea. Pueden existir definiciones diferentes a esta definición en otras áreas económicas o en aplicaciones militares. Por eso se deberá tener en cuenta que las palabras de señal aquí descritas sean utilizadas siempre solamente en combinación con la correspondiente documentación del producto y solamente en combinación con el producto correspondiente. La utilización de las palabras de señal en combinación con productos o documentaciones que no les correspondan puede llevar a interpretaciones equivocadas y tener por consecuencia daños en personas u objetos.

Estados operativos y posiciones de funcionamiento

El producto solamente debe ser utilizado según lo indicado por el fabricante respecto a los estados operativos y posiciones de funcionamiento sin que se obstruya la ventilación. Si no se siguen las indicaciones del fabricante, pueden producirse choques eléctricos, incendios y/o lesiones graves con posible consecuencia de muerte. En todos los trabajos deberán ser tenidas en cuenta las normas nacionales y locales de seguridad del trabajo y de prevención de accidentes.

1. El producto solamente debe ser utilizado según lo indicado por el fabricante referente a la situación y posición de funcionamiento. R&S FSH está protegido contra rociación y polvo (modo de protección IP 51). Si no se convino de otra manera, es para los productos Rohde & Schwarz válido lo que sigue: como posición de funcionamiento se define por principio la posición con el suelo de la caja para abajo, modo de protección IP 2X, grado de suciedad 2, categoría de sobrecarga eléctrica 2, uso solamente en estancias interiores, utilización hasta 4600 m sobre el nivel del mar, transporte hasta 12000 m sobre el nivel del mar. Se aplicará una tolerancia de $\pm 10\%$ sobre el voltaje nominal y de $\pm 5\%$ sobre la frecuencia nominal.
2. No ponga el producto sobre aparatos que generen calor (p. ej. radiadores o calefactores). La temperatura ambiente no debe superar la temperatura máxima especificada en la documentación del producto o en la hoja de datos. En caso de sobrecalentamiento del producto, pueden producirse choques eléctricos, incendios y/o lesiones graves con posible consecuencia de muerte.

Seguridad eléctrica

Si no se siguen (o se siguen de modo insuficiente) las indicaciones del fabricante en cuanto a seguridad eléctrica, pueden producirse choques eléctricos, incendios y/o lesiones graves con posible consecuencia de muerte.

1. Antes de la puesta en marcha del producto se deberá comprobar siempre que la tensión preseleccionada en el producto coincida con la de la red de alimentación eléctrica.
2. Si el producto no está equipado con un interruptor para desconectarlo de la red, se deberá considerar el enchufe del cable de conexión como interruptor. En estos casos se deberá asegurar que el enchufe siempre sea de fácil acceso (de acuerdo con la longitud del cable de conexión, aproximadamente 2 m). Los interruptores de función o electrónicos no son aptos para el corte de la red eléctrica. Si los productos sin interruptor están integrados en bastidores o instalaciones, se deberá colocar el interruptor en el nivel de la instalación.
3. No utilice nunca el producto si está dañado el cable de conexión a red. Compruebe regularmente el correcto estado de los cables de conexión a red. Asegúrese, mediante las medidas de protección y de instalación adecuadas, de que el cable de conexión a red no pueda ser dañado o de que nadie pueda ser dañado por él, p. ej. al tropezar o por un choque eléctrico.
4. Solamente está permitido el funcionamiento en redes de alimentación TN/TT aseguradas con fusibles de 16 A como máximo (utilización de fusibles de mayor amperaje solo previa consulta con el grupo de empresas Rohde & Schwarz).
5. Nunca conecte el enchufe en tomas de corriente sucias o llenas de polvo. Introduzca el enchufe por completo y fuertemente en la toma de corriente. La no observación de estas medidas puede provocar chispas, fuego y/o lesiones.
6. No sobrecargue las tomas de corriente, los cables alargadores o las regletas de enchufe ya que esto podría causar fuego o choques eléctricos.

7. En las mediciones en circuitos de corriente con una tensión $U_{eff} > 30$ V se deberán tomar las medidas apropiadas para impedir cualquier peligro (p. ej. medios de medición adecuados, seguros, limitación de tensión, corte protector, aislamiento etc.).
8. Para la conexión con dispositivos informáticos como un PC o un ordenador industrial, debe comprobarse que éstos cumplan los estándares IEC60950-1/EN60950-1 o IEC61010-1/EN 61010-1 válidos en cada caso.
9. A menos que esté permitido expresamente, no retire nunca la tapa ni componentes de la carcasa mientras el producto esté en servicio. Esto pone a descubierto los cables y componentes eléctricos y puede causar lesiones, fuego o daños en el producto.
10. En el caso de dispositivos fijos que no estén provistos de fusibles, interruptor automático ni otros mecanismos de seguridad similares, el circuito de alimentación debe estar protegido de modo que todas las personas que puedan acceder al producto, así como el producto mismo, estén a salvo de posibles daños.
11. Todo producto debe estar protegido contra sobretensión (debida p. ej. a una caída del rayo) mediante los correspondientes sistemas de protección. Si no, el personal que lo utilice quedará expuesto al peligro de choque eléctrico.
12. No debe introducirse en los orificios de la caja del aparato ningún objeto que no esté destinado a ello. Esto puede producir cortocircuitos en el producto y/o puede causar choques eléctricos, fuego o lesiones.
13. Salvo indicación contraria, los productos no están impermeabilizados (ver también el capítulo "Estados operativos y posiciones de funcionamiento", punto 1). Por eso es necesario tomar las medidas necesarias para evitar la entrada de líquidos. En caso contrario, existe peligro de choque eléctrico para el usuario o de daños en el producto, que también pueden redundar en peligro para las personas.
14. Antes de la limpieza, desconecte por completo el producto de la alimentación de tensión (p. ej. red de alimentación o batería). Realice la limpieza de los aparatos con un paño suave, que no se deshilache. No utilice bajo ningún concepto productos de limpieza químicos como alcohol, acetona o diluyentes para lacas nitrocelulósicas.

Funcionamiento

1. El uso del producto requiere instrucciones especiales y una alta concentración durante el manejo. Debe asegurarse que las personas que manejen el producto estén a la altura de los requerimientos necesarios en cuanto a aptitudes físicas, psíquicas y emocionales, ya que de otra manera no se pueden excluir lesiones o daños de objetos. El empresario u operador es responsable de seleccionar el personal usuario apto para el manejo del producto.
2. Antes de desplazar o transportar el producto, lea y tenga en cuenta el capítulo "Transporte".

3. Como con todo producto de fabricación industrial no puede quedar excluida en general la posibilidad de que se produzcan alergias provocadas por algunos materiales empleados, los llamados alérgenos (p. ej. el níquel). Si durante el manejo de productos Rohde & Schwarz se producen reacciones alérgicas, como p. ej. irritaciones cutáneas, estornudos continuos, enrojecimiento de la conjuntiva o dificultades respiratorias, debe avisarse inmediatamente a un médico para investigar las causas y evitar cualquier molestia o daño a la salud.
4. Antes de la manipulación mecánica y/o térmica o el desmontaje del producto, debe tenerse en cuenta imprescindiblemente el capítulo "Eliminación", punto 1.
5. Ciertos productos, como p. ej. las instalaciones de radiocomunicación RF, pueden a causa de su función natural, emitir una radiación electromagnética aumentada. Deben tomarse todas las medidas necesarias para la protección de las mujeres embarazadas. También las personas con marcapasos pueden correr peligro a causa de la radiación electromagnética. El empresario/operador tiene la obligación de evaluar y señalar las áreas de trabajo en las que exista un riesgo elevado de exposición a radiaciones.
6. Tenga en cuenta que en caso de incendio pueden desprenderse del producto sustancias tóxicas (gases, líquidos etc.) que pueden generar daños a la salud. Por eso, en caso de incendio

Reparación y mantenimiento

1. El producto solamente debe ser abierto por personal especializado con autorización para ello. Antes de manipular el producto o abrirlo, es obligatorio desconectarlo de la tensión de alimentación, para evitar toda posibilidad de choque eléctrico.
2. El ajuste, el cambio de partes, el mantenimiento y la reparación deberán ser efectuadas solamente por electricistas autorizados por Rohde & Schwarz. Si se reponen partes con importancia para los aspectos de seguridad (p. ej. el enchufe, los transformadores o los fusibles), solamente podrán ser sustituidos por partes originales. Después de cada cambio de partes relevantes para la seguridad deberá realizarse un control de seguridad (control a primera vista, control del conductor de protección, medición de resistencia de aislamiento, medición de la corriente de fuga, control de funcionamiento). Con esto queda garantizada la seguridad del producto.

Baterías y acumuladores o celdas

Si no se siguen (o se siguen de modo insuficiente) las indicaciones en cuanto a las baterías y acumuladores o celdas, pueden producirse explosiones, incendios y/o lesiones graves con posible consecuencia de muerte. El manejo de baterías y acumuladores con electrolitos alcalinos (p. ej. celdas de litio) debe seguir el estándar EN 62133.

1. No deben desmontarse, abrirse ni triturarse las celdas.
2. Las celdas o baterías no deben someterse a calor ni fuego. Debe evitarse el almacenamiento a la luz directa del sol. Las celdas y baterías deben mantenerse limpias y secas. Limpiar las conexiones sucias con un paño seco y limpio.

3. Las celdas o baterías no deben cortocircuitarse. Es peligroso almacenar las celdas o baterías en estuches o cajones en cuyo interior puedan cortocircuitarse por contacto recíproco o por contacto con otros materiales conductores. No deben extraerse las celdas o baterías de sus embalajes originales hasta el momento en que vayan a utilizarse.
4. Mantener baterías y celdas fuera del alcance de los niños. En caso de ingestión de una celda o batería, avisar inmediatamente a un médico.
5. Las celdas o baterías no deben someterse a impactos mecánicos fuertes indebidos.
6. En caso de falta de estanqueidad de una celda, el líquido vertido no debe entrar en contacto con la piel ni los ojos. Si se produce contacto, lavar con agua abundante la zona afectada y avisar a un médico.
7. En caso de cambio o recarga inadecuados, las celdas o baterías que contienen electrolitos alcalinos (p. ej. las celdas de litio) pueden explotar. Para garantizar la seguridad del producto, las celdas o baterías solo deben ser sustituidas por el tipo Rohde & Schwarz correspondiente (ver lista de recambios).
8. Las baterías y celdas deben reciclarse y no deben tirarse a la basura doméstica. Las baterías o acumuladores que contienen plomo, mercurio o cadmio deben tratarse como residuos especiales. Respete en esta relación las normas nacionales de eliminación y reciclaje.

Transporte

1. Las asas instaladas en los productos sirven solamente de ayuda para el transporte del producto por personas. Por eso no está permitido utilizar las asas para la sujeción en o sobre medios de transporte como p. ej. grúas, carretillas elevadoras de horquilla, carros etc. Es responsabilidad suya fijar los productos de manera segura a los medios de transporte o elevación. Para evitar daños personales o daños en el producto, siga las instrucciones de seguridad del fabricante del medio de transporte o elevación utilizado.
2. Si se utiliza el producto dentro de un vehículo, recae de manera exclusiva en el conductor la responsabilidad de conducir el vehículo de manera segura y adecuada. El fabricante no asumirá ninguna responsabilidad por accidentes o colisiones. No utilice nunca el producto dentro de un vehículo en movimiento si esto pudiera distraer al conductor. Asegure el producto dentro del vehículo debidamente para evitar, en caso de un accidente, lesiones u otra clase de daños.

Eliminación

1. Si se trabaja de manera mecánica y/o térmica cualquier producto o componente más allá del funcionamiento previsto, pueden liberarse sustancias peligrosas (polvos con contenido de metales pesados como p. ej. plomo, berilio o níquel). Por eso el producto solo debe ser desmontado por personal especializado con formación adecuada. Un desmontaje inadecuado puede ocasionar daños para la salud. Se deben tener en cuenta las directivas nacionales referentes a la eliminación de residuos.

Customer Support

Technical support – where and when you need it

For quick, expert help with any Rohde & Schwarz equipment, contact one of our Customer Support Centers. A team of highly qualified engineers provides telephone support and will work with you to find a solution to your query on any aspect of the operation, programming or applications of Rohde & Schwarz equipment.

Up-to-date information and upgrades

To keep your instrument up-to-date and to be informed about new application notes related to your instrument, please send an e-mail to the Customer Support Center stating your instrument and your wish. We will take care that you will get the right information.

Europe, Africa, Middle East

Phone +49 89 4129 12345
customersupport@rohde-schwarz.com

North America

Phone 1-888-TEST-RSA (1-888-837-8772)
customer.support@rsa.rohde-schwarz.com

Latin America

Phone +1-410-910-7988
customersupport.la@rohde-schwarz.com

Asia/Pacific

Phone +65 65 13 04 88
customersupport.asia@rohde-schwarz.com

China

Phone +86-800-810-8228 /
+86-400-650-5896
customersupport.china@rohde-schwarz.com



Table of Contents

Safety Instructions	4
Instrucciones de seguridad	5
Sicherheitshinweise	6
Consignes de sécurité	7
Documentation Overview	8
Support Center	10
1 Putting into Operation	11
1.1 Unpacking the R&S FSH	12
1.2 Overview of Controls	13
1.3 Setting up the R&S FSH	14
1.3.1 Using the AC Adapter	15
1.3.2 Battery Operation.....	16
1.3.3 Battery Maintenance	18
1.3.3.1 Handling.....	18
1.3.3.2 Storage	18
1.3.3.3 Transportation.....	19
1.3.3.4 End of Life.....	19
1.4 Connectors on the R&S FSH	20
1.4.1 RF Input	21
1.4.2 Tracking Generator Output.....	22
1.4.3 Power Sensor Port.....	22
1.4.4 Headphone Jack.....	23
1.4.5 AUX Input.....	23
1.4.6 BNC Connectors	24
1.4.6.1 EXT TRIG / EXT REF	24
1.4.6.2 BIAS Port 1 / BIAS Port 2	24
1.4.6.3 IF Output.....	25
1.4.7 Mini USB and LAN Ports	26
1.4.8 Mechanical Locking Device	26

1.4.9	DC Port	27
1.4.10	USB Port	27
1.4.11	SD Card Slot	27
1.5	Managing Options.....	28
1.5.1	Enabling Options.....	28
1.5.2	Checking Installed Options	28
1.5.3	Managing Options with the R&S License Manager	29
1.6	Configuring the R&S FSH	31
1.6.1	Configuring the Hardware.....	32
1.6.2	Configuring Antennas	34
1.6.3	Using the GPS Receiver	37
1.6.4	Configuring Date and Time.....	39
1.6.5	Selecting Regional Attributes.....	40
1.6.6	Configuring the Display.....	41
1.6.7	Configuring Audio Output	42
1.6.8	Configuring Power Supply	43
1.6.9	Self Alignment.....	44
1.6.10	Using a PIN Code	44
1.6.11	Resetting the R&S FSH	45
1.7	Connecting the R&S FSH to a PC	46
1.7.1	Connecting the R&S FSH in a LAN	46
1.7.2	Connecting the R&S FSH in an existing LAN	49
1.7.3	Connecting the R&S FSH via USB	50
2	Getting Started	51
2.1	Using the Spectrum Analyzer.....	52
2.1.1	Attenuating the Signal.....	52
2.1.2	Using the Preamplicifier	53
2.1.3	Measuring CW Signals	54
2.1.4	Measuring Harmonics	57
2.2	Using the Network Analyzer	59
2.2.1	Calibrating the R&S FSH	60
2.2.2	Measuring the Vector Reflection.....	62
2.2.3	Measuring Scalar Transmission	63

2.3 Using a Power Sensor	64
2.3.1 Measuring the Power with a Power Sensor.....	65
2.3.2 Measuring Power and Return Loss	67
2.4 Identifying Cable Faults	69
2.5 Saving and Recalling Results and Settings	73
2.5.1 Saving Measurement Results.....	73
2.5.2 Recalling Measurement Results.....	74
Index	75

Safety Instructions

 WARNING**Risk of injury and instrument damage**

The instrument must be used in an appropriate manner to prevent personal injury or instrument damage.

- Do not open the instrument casing.
 - Read and observe the "Basic Safety Instructions" delivered as printed brochure with the instrument or in electronic format on the documentation CD-ROM.
 - Read and observe the safety instructions in the following sections. Note that the data sheet may specify additional operating conditions.
 - Keep the "Basic Safety Instructions" and the product documentation in a safe place and pass them on to the subsequent users.
-

The R&S FSH has been designed for lab operation as well as for service and maintenance applications in outdoor areas. Thus, the following safety instructions apply in addition to or contrary to the "Basic Safety Instructions" leaflet.

1. The R&S FSH is protected against dripping water and dust (IP degree 51) and can thus be used in outdoor areas to a certain degree.
2. The R&S FSH's max. operating altitude is 4600 m above sea level and its max. transport altitude is 12000 m above sea level.

Instrucciones de seguridad

ADVERTENCIA

Riesgo de lesiones y daños en el instrumento

El instrumento se debe usar de manera adecuada para prevenir descargas eléctricas, incendios, lesiones o daños materiales.

- No abrir la carcasa del instrumento.
- Lea y cumpla las "Instrucciones de seguridad elementales" suministradas con el instrumento como folleto impreso o en formato electrónico en el CD-ROM de documentación.
- Lea y cumpla las instrucciones de seguridad incluidas en las siguientes secciones. Se debe tener en cuenta que las especificaciones técnicas pueden contener condiciones adicionales para su uso.
- Guarde bien las instrucciones de seguridad elementales, así como la documentación del producto, y entréguelas a usuarios posteriores.

El R&S FSH está diseñado tanto para el uso en el laboratorio como para aplicaciones de servicio y mantenimiento al aire libre. En consecuencia, las instrucciones de seguridad siguientes son aplicables de manera adicional a las "Informaciones elementales de seguridad" (folleto) o en lugar de estas en los puntos en los que diverjan.

1. El R&S FSH está protegido contra las salpicaduras de agua y contra el polvo (IP 51), por lo que hasta cierto punto se puede usar en exteriores sin problemas.
2. La altitud máxima de funcionamiento del R&S FSH es de 4600 m sobre el nivel del mar, mientras que su altitud máxima de transporte es de 12 000 m sobre el nivel del mar.

Sicherheitshinweise

WARNUNG

Gefahr von Verletzungen und Schäden am Gerät

Betreiben Sie das Gerät immer ordnungsgemäß, um elektrischen Schlag, Brand, Verletzungen von Personen oder Geräteschäden zu verhindern.

- Öffnen Sie das Gerätegehäuse nicht.
 - Lesen und beachten Sie die "Grundlegenden Sicherheitshinweise", die als gedruckte Broschüre dem Gerät beiliegen oder elektronisch auf der Dokumentation CD-ROM zu finden sind.
 - Lesen und beachten Sie die Sicherheitshinweise in den folgenden Abschnitten; möglicherweise enthält das Datenblatt weitere Hinweise zu speziellen Betriebsbedingungen.
 - Bewahren Sie die "Grundlegenden Sicherheitshinweise" und die Produktdokumentation gut auf und geben Sie diese an weitere Benutzer des Produkts weiter.
-

Der R&S FSH wurde für den Einsatz im Labor sowie für Service- und Wartungseinsätze im Freien entwickelt. Deshalb gelten zusätzlich oder im Gegensatz zur Broschüre „Grundlegende Sicherheitshinweise“ die folgenden Sicherheitshinweise.

1. Der R&S FSH ist gegen Spritzwasser und Staub geschützt (IP-Schutzart 51) und kann daher bis zu einem gewissen Grad im Freien verwendet werden.
2. Die maximale Betriebshöhe des R&S FSH beträgt 4600 m ü. NN und die maximale Transporthöhe 12000 m ü. NN

Consignes de sécurité

AVERTISSEMENT

Risque de blessures et d'endommagement de l'appareil

L'appareil doit être utilisé conformément aux prescriptions afin d'éviter les électrocutions, incendies, dommages corporels et matériels.

- N'ouvrez pas le boîtier de l'appareil.
- Lisez et respectez les "consignes de sécurité fondamentales" fournies avec l'appareil sous forme de brochure imprimée ou disponibles en format électronique sur le CD-ROM de documentation.
- Lisez et respectez les instructions de sécurité dans les sections suivantes. Il ne faut pas oublier que la fiche technique peut indiquer des conditions d'exploitation supplémentaires.
- Gardez les consignes de sécurité fondamentales et la documentation produit dans un lieu sûr et transmettez ces documents aux autres utilisateurs.

Le R&S FSH a été conçu pour le fonctionnement en laboratoire ainsi que pour les applications de service et de maintenance en extérieur. Par conséquent, les instructions de sécurité suivantes s'appliquent en plus de la fiche « Consignes fondamentales de sécurité » ou s'opposent à elles.

1. Le R&S FSH est protégé contre les projections d'eau et la poussière (niveau de protection IP 51) et peut par conséquent être utilisé en extérieur dans une certaine mesure.
2. Le R&S FSH est utilisable jusqu'à une altitude maximale de 4600 m au-dessus du niveau de la mer, et peut être transporté à une altitude maximale de 12000 m au-dessus du niveau de la mer.

Documentation Overview

The user documentation for the R&S FSH is divided as follows:

Quick Start Guide

The Quick Start Guide provides basic information on the instrument's functions.

It covers the following topics:

- overview of all elements of the front and rear panels
- basic information on how to set up the R&S FSH
- information on how to operate the R&S FSH in a network
- instructions on how to perform measurements

Operating Manual

The Operating Manual provides a detailed description on the instrument's functions

It covers the following topics:

- instructions on how to set up and operate the R&S FSH in its various operating modes
- instructions on how to perform measurements with the R&S FSH
- instructions on how to work with the available software options and applications

Manual for Remote Control Operation

The software manual for the R&S FSH-K40 provides a detailed description of the remote control option.

It covers the following topics:

- introduction to the operation of the R&S FSH via remote control
- detailed description of the remote control commands available with the R&S FSH-K40 software application.
- description of the status reporting system

Service Manual

The Service Manual provides information on maintenance.

It covers the following topics:

- instructions on how to perform a performance test
- instructions on how to repair the R&S FSH including a spare parts list
- mechanical drawings

Release Notes

The release notes describe the installation of the firmware, new and modified functions, eliminated problems, and last minute changes to the documentation. The corresponding firmware version is indicated on the title page of the release notes. The current release notes are provided on the internet.

Internet Site

The internet site at: <http://www.rohde-schwarz.com/product/fsh.html> provides the most up to date information on the R&S FSH. The most recent manuals are available as printable PDF files in the download area.

Also provided for download are firmware updates including the corresponding release notes, instrument drivers, current data sheets, application notes and image versions.

Support Center

Technical support – where and when you need it

For quick, expert help with any Rohde & Schwarz equipment, contact one of our Customer Support Centers. A team of highly qualified engineers provides telephone support and will work with you to find a solution to your query on any aspect of the operation, programming or applications of Rohde & Schwarz equipment.

Up-to-date information and upgrades

To keep your instrument up-to-date and to be informed about new application notes related to your instrument, please send an e-mail to the Customer Support Center stating your instrument and your wish. We will take care that you will get the right information.

Europe, Africa, Middle East

Phone +49 89 4129 12345*
customersupport@rohde-schwarz.com

North America

Phone 1-888-TEST-RSA (1-888-837-8772)
customer.support@rsa.rohde-schwarz.com

Latin America

Phone +1-410-910-7988
customersupport.la@rohde-schwarz.com

Asia/Pacific

Phone +65 65 13 04 88
customersupport.asia@rohde-schwarz.com

China

Phone: +86-800-810-8228 /
+86-400-650-5896
customersupport.china@rohde-schwarz.com

*0.14 Euro/min within German fixed-line telephone network, varying prices for the mobile telephone network and in different countries.

1 Putting into Operation

This chapter assists you in using the R&S FSH for the first time.

It contains general information about the R&S FSH as well as information about the available connectors and the general system configuration.

Contents

- [Unpacking the R&S FSH](#) (p. 12)
- [Overview of Controls](#) (p. 13)
- [Setting up the R&S FSH](#) (p. 14)
- [Connectors on the R&S FSH](#) (p. 20)
- [Managing Options](#) (p. 28)
- [Configuring the R&S FSH](#) (p. 31)
- [Connecting the R&S FSH to a PC](#) (p. 46)

1.1 Unpacking the R&S FSH

The R&S FSH is delivered in formfitting packaging. It consists of an upper and a lower shell. The two shells are held together by tape.

The packaging contains all accessories that are supplied with the instrument.

- ▶ Remove the tape and open the packaging.
- ▶ Remove the R&S FSH and its accessories.
- ▶ Remove the protective film from the screen.

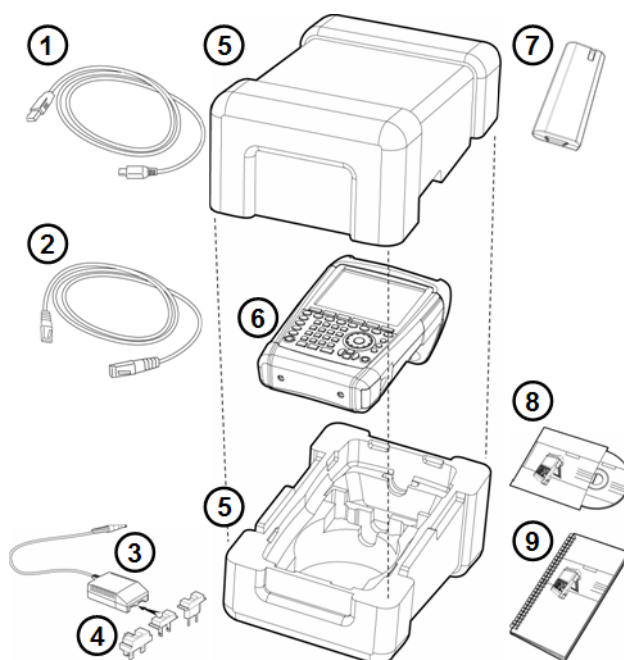

- | | |
|---|----------------------------|
| 1 | USB cable |
| 2 | LAN cable |
| 3 | AC adapter |
| 4 | AC plug (country specific) |
| 5 | Upper and lower shell |
| 6 | R&S FSH |
| 7 | Lithium ion battery |
| 8 | CD-ROM |
| 9 | Quick Start manual |

1.2 Overview of Controls



- 1 RF input (N-connector)
- 2 Headphone jack
- 3 BNC connectors (behind protective cap)
- 4 LAN and Mini USB ports (behind protective cap)
- 5 Softkey labels (on display)
- 6 Softkeys
- 7 Function keys
- 8 Alphanumeric keypad
- 9 Kensington lock
- 10 DC port
- 11 On/Off key
- 12 Entry keys
- 13 Unit keys
- 14 Cursor keys
- 15 Preset key
- 16 Rotary knob
- 17 Screenshot key
- 18 Setup key
- 19 Display
- 20 SD card slot / USB port (behind protective cap)
- 21 Tracking generator output (N-connector)
- 22 Power sensor jack

1.3 Setting up the R&S FSH

The R&S FSH has been designed for lab operation as well as for service and maintenance applications on-site.

Depending on the environment, you can adjust the viewing angle of the display and either lay it out flat or prop it up using the support on the back of the R&S FSH.



When laid out flat for operation from above, the R&S FSH is still tilted slightly because of the grip on its top. This position provides the optimum viewing angle for the display.

To allow easy operation from the front and still be able to read the display, you can swing out the support on the back of the R&S FSH.

For use on site or service measurements, it is best to hold the instrument in both hands. All controls are easy to reach. It is also recommended to use the R&S HA-Z222 carrying bag in order to leave both hands free for work on the device under test (DUT).

You can also use the grip on the top of the R&S FSH to hang it from cabinet doors, for example.

Before you turn on the R&S FSH, you should insert the lithium ion battery included in the delivery into the battery compartment. The battery compartment is located on the bottom right of the R&S FSH.

(1) Press a finger against the recessed grip and push the cover down.

(2) Open the cover.

(3) Insert the battery into the compartment with the round side facing upwards and the handle facing outwards.

(4) Close the cover.

(5) Push the cover up until it clicks fully into place.

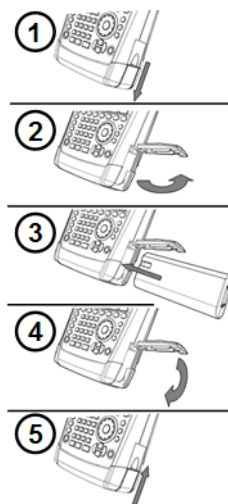

You can operate the R&S FSH with the AC adapter or the battery. Both are included in the delivery.

1.3.1 Using the AC Adapter

Connect the AC adapter (R&S HA-Z201) to the DC port on the left side of the R&S FSH (1). Make sure to fully insert the plug into the port.

Depending on the system you need, firmly connect the appropriate plug included in the delivery (2) to the AC adapter.

Finally, connect the plug to an AC power outlet.

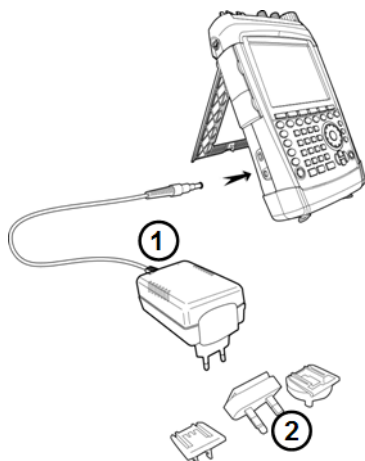

The voltage range of the AC power supply is 100 V to 240 V AC.

When the R&S FSH is supplied with power, you can turn it on with the  button on the front panel.

NOTICE

Risk of instrument damage

To avoid instrument damage,

- only use the power supply included in the delivery (R&S HA-Z201).
 - make sure that AC supply voltage is compatible to the voltage specified on the power supply unit.
 - attach the appropriate adapter to the power supply.
-

1.3.2 Battery Operation

The lithium ion battery has a capacity of approximately 4 Ah and allows operation of up to three hours when it is fully charged.

The actual operation time depends on the current charge status, the ambient temperature and the operating mode of the R&S FSH.

The R&S FSH shows the current charge status at the top of the display.



When fully charged, the battery icon is completely white. As the battery loses power, the white color in the battery icon fades away until it turns red and starts to blink. When the icon starts to blink, the battery low level has been reached. For more information see "[Configuring Power Supply](#)" on page 43.

Note that the battery is not fully charged when it is dispatched. For battery operation you have to charge it first.

To charge the battery, connect the AC power adapter included in the delivery. For more information see "[Using the AC Adapter](#)" on page 15.

Charging time is about 2.5 hours when the R&S FSH is switched off. If it is switched on, the charging time is extended to about 3.5 hours, because the charging current is reduced by the power drain of the R&S FSH.

During operation in the field, you can also charge the battery with the R&S HA-Z202 car adapter (order no. 1309.6117.00). You can connect the car adapter to the DC port. With the car adapter, you are able to charge the R&S FSH via the car's cigarette lighter socket.

While charging, the R&S FSH displays an arrow within the battery charge status indicator at the top right of the display to show that it is connected to the power supply and is charging.



When the battery is fully charged (or when you use the R&S FSH without a battery), a plug icon is displayed instead of the battery icon.



You can set up the R&S FSH to automatically turn off if no input is made after a particular time period. The possible range is from 0 to 99 minutes. For more information see "[Configuring the Display](#)" on page 41.

In the default state, the automatic cut-off is inactive.

A replacement battery (R&S FSH-Z206) with a capacity of approximately 6 Ah and an operating time of 4.5 hours is available as an accessory. Charging time for the replacement battery is about 3.5 hours if the R&S FSH is switched off and about 4.5 hours if the R&S FSH is switched on.

Using an external battery charger

You can also use an external battery charger (R&S HA-Z203, order no. 1309.6123.00) to charge an additional replacement battery.

To charge the battery externally, put the battery into the external charger and supply it with power via the AC power adapter.

An orange LED (CHARGE) on the charger indicates the charging process. The orange LED turns off when the battery is fully charged. When the battery is fully charged, a green LED (READY) turns on instead.

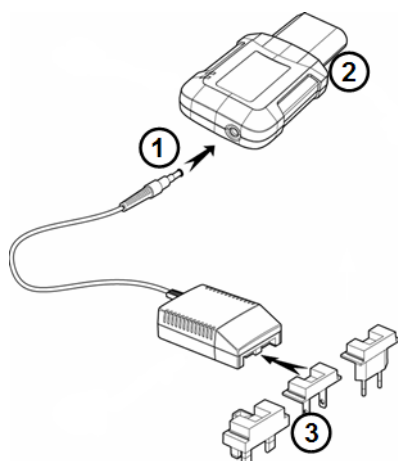

- 1 External charger R&S HA-Z203
- 2 Lithium ion battery R&S HA-Z204 or HA-Z206
- 3 Power supply unit R&S Z201 or car adapter R&S HA-Z202

⚠ WARNING

Turn off the R&S FSH while driving or while the engine is on.

Operation of the R&S FSH via the cigarette lighter socket while driving or while the engine is on is prohibited.

1.3.3 Battery Maintenance

The R&S FSH comes with a lithium-ion battery. In general, these batteries are easy to handle. When you handle the battery, mind the things mentioned in the safety instructions and those in this chapter.

1.3.3.1 Handling

- The battery has been designed for a specific application. Do not use it for any other application
- Do not connect batteries in series or parallel as it can cause serious damage.
- Observe correct polarities during installation and charging.
- Do not heat over 70°C. The battery contains thermal fuses that could activate and render the battery inoperable.
- The battery contains an electronic device for protection against deep discharge, overcharge and short-circuiting between the terminals.
 - If you cannot discharge the battery, it may be deep discharged. Charge the battery for 0.5 hours and check again.
 - If you cannot charge the battery, it may be overcharged. Discharge the battery and check again.
 - If the battery has been short-circuited, charge it to reset the electronics.
 - If the battery still does not work, contact the Rohde & Schwarz customer support.
- Do not allow metallic objects to come into contact with the terminals.
- Do not solder directly to the battery.

1.3.3.2 Storage

The battery self-discharges while not in use. When storing the battery for an extended period of time, make sure to

- handle the battery carefully to avoid short circuits. Make sure that leads and terminals are insulated.
- keep the battery in the supplied packaging prior to use. The temperature should not exceed 30°C.
- store the battery at an initial state of charge between 15% and 50% of its capacity. When calculating the initial state of charge, consider
 - the maximum consumption of electronic devices
 - the self-discharge of the battery - the higher the state of charge, the higher the rate of self-discharge
- avoid a deep discharge of the battery. A deep discharge occurs when the state of charge falls below 5% of the battery's capacity.
- recharge the battery at least every six months.

Should the battery voltage be low or even 0 V, the battery protection circuit may have gone into a sleep mode. In that case, reset the battery with an approved charger.

1.3.3.3 Transportation

No special regulations apply for transporting the battery. The battery cells contain no metallic lithium.

1.3.3.4 End of Life

The capacity of the battery decreases after it has gone through numerous charge cycles and nears its end of life. When the battery is dead, do not open the battery. Dispose of it at a suitable collection point.

1.4 Connectors on the R&S FSH

The R&S FSH has several connectors. The connectors are either on the upper, left or right side.

Contents

- [RF Input](#) (p. 21)
- [Tracking Generator Output](#) (p. 22)
- [Power Sensor Port](#) (p. 22)
- [Headphone Jack](#) (p. 23)
- [AUX Input](#) (p. 23)
- [BNC Connectors](#) (p. 24)
- [Mini USB and LAN Ports](#) (p. 26)
- [Mechanical Locking Device](#) (p. 26)
- [DC Port](#) (p. 27)
- [USB Port](#) (p. 27)
- [SD Card Slot](#) (p. 27)

1.4.1 RF Input

The RF input is located on the top of the R&S FSH.



Connect a cable or DUT to the RF input with an N connector. Use a cable to connect the DUT to the R&S FSH, if necessary.

Make sure not to overload the R&S FSH when a DUT is connected.

The maximum power that is permissible at the RF input is 20 dBm (or 100 mW).

The R&S FSH may be loaded with up to 30 dBm (or 1 W) for up to three minutes. If you apply 1 W for a longer period, the R&S FSH may be destroyed.

The RF input is protected from static discharges and voltage pulses by a limiting circuit.

WARNING

Risk of electrical shock

In order to avoid electrical shock, the DC input voltage must never exceed the value specified on the housing.

NOTICE

Risk of instrument damage

To avoid damage to the coupling capacitor, input attenuator or the mixer, the DC input voltage must never exceed the value specified in the data sheet.

1.4.2 Tracking Generator Output

The tracking generator output is located on the top of the R&S FSH.



The tracking generator output power of the R&S FSH is 0 dBm nominal.

With an integrated step attenuator, you can reduce the tracking generator output power by a maximum of 40 dB in 1 dB steps.

NOTICE

Risk of instrument damage

To avoid damage to the tracking generator output, the reverse voltage up to the voltage stated on the R&S FSH housing must not be exceeded.

1.4.3 Power Sensor Port

The connector for power sensors is located on the top of the R&S FSH.



The connector is configured especially for power sensors. It is used for both the power supply and data transfer via the power sensor interface.

Additionally, you can connect accessories like the R&S TS-EMF isotropic antenna (order no. 1158.9295.13) to the power sensor port.

1.4.4 Headphone Jack

The 3.5 mm connector for headphones is located on the top of the R&S FSH.



The internal impedance of the connector is approximately 10 Ohm.

1.4.5 AUX Input

The AUX input is located on the left side of the R&S FSH under a protective cap.



You can connect various accessories like the GPS receiver R&S HA-Z240 (order no. 1309.6700.02) to the AUX connector.

1.4.6 BNC Connectors

The BNC connectors are located on the left side of the R&S FSH behind a protective cap.



You can configure both BNC connectors for various applications. The name of the connector is printed on the insides of the protective caps.

1.4.6.1 EXT TRIG / EXT REF

The first (upper) BNC connector supports an external trigger source or an external reference signal.

The external trigger is only for input configuration. It controls the start of a measurement and has to be selected in the "Sweep" menu. The trigger threshold is similar to that of TTL signals.

The 10 MHz reference signal that you can apply is used for frequency synchronization. The level of the reference signal must be larger than 0 dBm. When the BNC connector is configured for the external reference but no reference signal is present, the R&S FSH displays an appropriate message. Thus, measurements without a valid reference can be avoided.

For more information see "[Configuring the Hardware](#)" on page 32.

1.4.6.2 BIAS Port 1 / BIAS Port 2

When you use the BNC connectors as BIAS ports, the two BNC connectors are direct current inputs.

Active equipment under test can be supplied with power via the BIAS Port 1 and BIAS Port 2 direct current inputs. Direct current is supplied with the assistance of a suitable power adapter (600 mA max. / 50 V max.).

Using the BNC connectors as BIAS ports is only possible with R&S FSH models .24 and .28.

1.4.6.3 IF Output

The second (lower) BNC connector can be used as an intermediate frequency output (54.4 MHz).

NOTICE**Risk of instrument damage**

To avoid damage to the tracking generator output, never apply currents greater than 600 mA or voltages greater than 20 V to the BNC connectors if the BNC connectors are not configured as BIAS input ports.

If they are configured as BIAS ports, never apply currents greater than 600 mA or voltages greater than 50 V.

1.4.7 Mini USB and LAN Ports

The mini USB and LAN ports are located on the left side of the R&S FSH behind a protective cap.



You can connect the R&S FSH to a PC via USB or LAN and transfer data in both directions.

Configure the USB and LAN connection via the "Instrument Setup". For more information see "[Connecting the R&S FSH to a PC](#)" on page 46.

1.4.8 Mechanical Locking Device

A Kensington Lock can be anchored to the R&S FSH housing to secure the R&S FSH to a workstation mechanically.



1.4.9 DC Port

The DC port is located on the left side of the R&S FSH.



The R&S FSH is supplied with power by the AC/DC transformer power supply via the DC connector. You can also use the DC connector to charge the battery.

1.4.10 USB Port

R&S FSH models with a 20 MHz bandwidth feature an USB port (serial number 105000 and higher).

The USB port is located on the right side of the R&S FSH behind a protective cap.

You can use the USB interface to connect a memory stick and store data sets or screenshots, for example.

1.4.11 SD Card Slot

The SD Card slot is located on the right side of the R&S FSH behind a protective cap.

You can use an SD card to store data sets or screenshots, for example.

1.5 Managing Options

For special measurement tasks, you can equip the R&S FSH with various firmware options.

1.5.1 Enabling Options

To enable options, you have to enter a key code. The key code is based on the unique serial number of the R&S FSH.

- ▶ Press the SETUP key.
- ▶ Press the "Installed Options" softkey.
- ▶ Select the "Install Option..." item.
- ▶ Press the ENTER key.

The R&S FSH opens an input field to enter the option key.

- ▶ Enter the appropriate option key.
- ▶ Confirm the entry with the ENTER key.

If you have entered the correct code, the R&S FSH shows

Installation successful !

If you have entered an incorrect code, the R&S FSH shows

Invalid key code!

- ▶ Enter the correct code again.

1.5.2 Checking Installed Options

In the "Setup" menu, the R&S FSH shows all options that are currently installed.

- ▶ Press the SETUP key.
- ▶ Press the "Installed Options" softkey.

The R&S FSH shows a list of all available options and the current status of the option:

- "Installed": the option is installed and working.
- "Installed Portable": the option is installed and working, the license is a portable one.
- "Removed: <option key>": indicates that a portable license has been removed from the R&S FSH and is ready to be transferred to another R&S FSH.

1.5.3 Managing Options with the R&S License Manager

If you are using the R&S FSH in a local area network (LAN), you can manage firmware options with a web browser (e.g. Microsoft Internet Explorer or Mozilla Firefox).

For more information on connecting the R&S FSH to a LAN see "[Connecting the R&S FSH to a PC](#)" on page 46.

After you have connected the R&S FSH, open your web browser.

- ▶ Enter the IP address of the R&S FSH in the address bar of the web browser.



The browser will access the R&S License Manager. In this part of the R&S License Manager, you can install and activate licenses on the R&S FSH.

This page features three areas.

- The first area shows the details of the connected device including the device ID and the IP address.

Connected Device		
FSH4	Device ID:	1309.6000K24-900204-nK
FSH4	IP Address:	10.113.10.184
Version: V1.50	Host Name:	localhost

- The second area provides functionality to install and activate licenses.



- Install Registered License Keys and Activate Licenses

Follow this link if you have purchased a registered license. Registered licenses only work in combination with a specific device ID.

- Register Licenses, Install License Keys and Activate Licenses

Follow this link if you have purchased an unregistered license. Unregistered licenses are not connected to a specific device ID.

- Reboot Device

Follow this link to reboot the R&S FSH.



Opens a detailed online help to the corresponding topic.

- The third area provides hints on using the license manager when you move the mouse over one of the options.

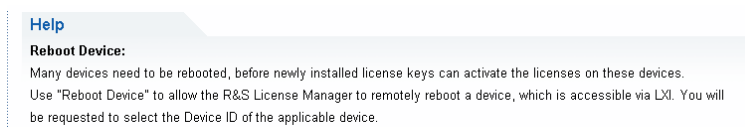

In case you already have one or more R&S FSH equipped with options, you can manage the licenses of these options on the license manager web page.

- ▶ Press the **Manage Licenses** button.

The browser will access another part of the R&S License Manager. In this part of the license manager you can manage licenses already installed on your R&S FSH.

This page features two areas.

- The first area provides functionality to manage licenses already installed on a device.



- Register Licenses

Follow this link if you have purchased an unregistered license. Unregistered licenses only work in combination with a specific device ID.

- Unregister License

Follow this link if you have installed a portable license. Portable licenses work in combination with several device IDs. However, you have to unregister it on one device before you can use it on another.

- Move Portable License

Follow this link if you want to move a portable license. Moving a portable license is possible without unregistering the license.

- 

Opens a detailed online help to the corresponding topic.

- The second area provides hints on using the R&S License Manager when you move the mouse over one of the options.

After you have followed one of the links, follow the instructions displayed in the browser. If you encounter any problems during the licensing procedure, you can access the online help at any time with the  icon. The online help contains an extensive description of all functionality that the license manager features.

1.6 Configuring the R&S FSH

In the "Instrument Setup" dialog box, the R&S FSH provides various general settings that are independent of the operating mode of the R&S FSH.

- ▶ Press the SETUP key.
- ▶ Press the "Instrument Setup" softkey.
The R&S FSH opens the corresponding dialog box.
- ▶ Select the item you want to modify with the rotary knob or the cursor keys.

Contents

- [Configuring the Hardware](#) (p. 32)
- [Configuring Antennas](#) (p. 34)
- [Using the GPS Receiver](#) (p. 37)
- [Configuring Date and Time](#) (p. 39)
- [Selecting Regional Attributes](#) (p. 40)
- [Configuring the Display](#) (p. 41)
- [Configuring Audio Output](#) (p. 42)
- [Configuring Power Supply](#) (p. 43)
- [Self Alignment](#) (p. 44)
- [Using a PIN Code](#) (p. 44)
- [Resetting the R&S FSH](#) (p. 45)

1.6.1 Configuring the Hardware

The hardware settings contain settings that control internal and connected hardware.

Hardware	
Auto Accessory Detection	On
Detected Accessory	
BNC 1	Trigger Input
BNC 2	IF Out

Using auto accessory detection

If you are using any accessories while working with the R&S FSH, the R&S FSH is able to identify the connected hardware.

- ▶ In the "Instrument Setup" dialog box, select the "Auto Accessory Detection" item.
- ▶ Press the ENTER key.
- ▶ Select the accessory detection state from the dropdown menu.



- ▶ Confirm the selection with the ENTER key.

When this feature is on, the name of the connected accessory is displayed in the "Detected Accessory" field.

Configuring the BNC connectors

You can use the BNC connectors for various applications. For more information on the supported applications, see "[BNC Connectors](#)" on page 24.

- ▶ In the "Instrument Setup" dialog box, select the "BNC 1" item.
- ▶ Press the ENTER key.

A dropdown menu to select the BNC connector application opens.



The following applications are available:

- Trigger input
- Reference signal input
- DC Bias Port 1 and Port 2
(Only with models .24 and .28.)

- ▶ Select the required application.
- ▶ Confirm the selection with the ENTER key.

The way to configure the second BNC connector is similar.

- ▶ Instead of selecting the "BNC 1" item, select the "BNC 2" item.



The following applications are available:

- IF output
- DC Bias Port 1 and Port 2
(Only with models .24 and .28.)

1.6.2 Configuring Antennas

You can use the log-periodic antenna R&S HL300 (order no. 4097.3005.02) or the active directional antenna R&S HE300 with the R&S FSH to locate potential interfering sources.

For a comprehensive description of the antennas and their functionality, refer to the user manuals delivered with the product.

Both antennas feature a GPS receiver and an electronic compass. You can control the GPS receiver of the antennas as described in "Using the GPS Receiver".

- ▶ To work with the R&S HL300, connect it to the AUX input and the RF input.
- ▶ To work with the R&S HE300, connect it to the power sensor connector.

The "Instrument Setup" dialog box provides all settings necessary to control the antenna.

HL300 Antenna	
HL300 Antenna	Enabled
Compass	Enabled
Show Compass Information	Disabled
Assign Antenna Switch to	Preamplifier
Magnetic Declination	0.0
Antenna Service Menu	

Enabling the antenna

- ▶ In the "Instrument Setup" dialog box, select the "HL300 Antenna" or the "HE300 Antenna" item.
- ▶ Press the ENTER key.

The R&S FSH opens a dropdown menu to select the connected antenna model.

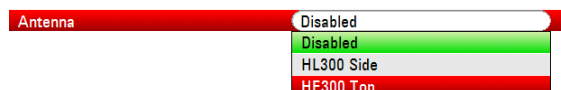

- ▶ Turn the antenna on or off.
- ▶ Confirm the selection with the ENTER key.

Enabling the compass

The antennas feature an electronic compass to determine directions precisely.

- ▶ In the "Instrument Setup" dialog box, select the "Compass" item.
- ▶ Press the ENTER key.

The R&S FSH opens a dropdown menu to turn the compass on and off.

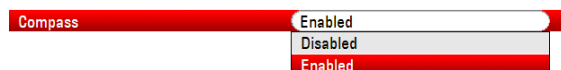

- ▶ Turn the compass on or off.
- ▶ Confirm the selection with the ENTER key.

Note that the R&S FSH also shows the magnetic declination of your current position in the dialog box when you turn on the compass.

Showing compass information

- ▶ In the "Instrument Setup" dialog box, select the "Show Compass Information" item.
- ▶ Press the ENTER key.

The R&S FSH opens a dropdown menu to turn the display of directions on and off.



- ▶ Turn compass information on or off as required.
- ▶ Confirm the selection with the ENTER key.

When this feature is on, the R&S FSH displays the compass information at the top of the display

Assigning functions to the toggle switch

The R&S HL300 has a toggle switch on its handle that you can assign one of several functions to.

- ▶ In the "Instrument Setup" dialog box, select the "Assign Antenna Switch" item.
- ▶ Press the ENTER key.

The R&S FSH opens a dropdown menu to select the function of the toggle switch.



- Preamplifier
Using the toggle switch turns the preamplifier on and off.
- Save current GPS position
Using the toggle switch tags your current position in the map material.

- ▶ Select the menu item as required.
- ▶ Confirm the selection with the ENTER key.

The R&S HE300 also has a toggle switch, but it always turns the internal preamplifier of the antenna on and off. When this preamplifier is on, the R&S FSH displays an antenna icon in the hardware settings.

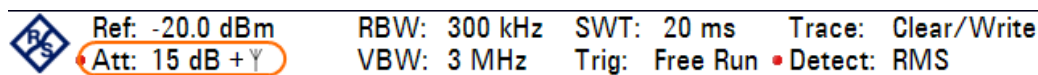

Calibrating the antenna

If you need to know specifics about the antenna, for example for service or support, you can get the necessary information in the "Antenna Service Menu" provided on the R&S FSH.

The "Antenna Service Menu" also contains functionality to calibrate the antenna.

- ▶ In the "Instrument Setup" dialog box, select the "Antenna Service Menu" item.



The R&S FSH informs you that it will turn off the antenna to determine the antenna information.

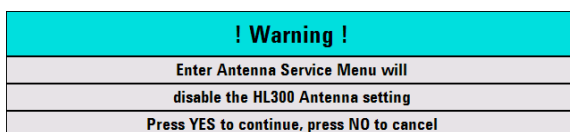

- ▶ Press the "Yes" softkey.

The R&S FSH tries to determine the antenna characteristics. It shows the results in a dialog box.

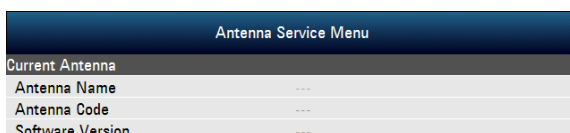

- ▶ Press the "Calibrate" softkey.

The R&S FSH starts the calibration.

For antenna calibration, it is necessary to point the antenna in different directions. Follow the instructions on the screen to successfully calibrate the antenna.

1.6.3 Using the GPS Receiver

The R&S FSH can locate your exact position if you equip it with the R&S HS-Z240 GPS receiver (order no. 1309.6700.02) or one of the supported antennas R&S HL300 or R&S HE300.

- The GPS receiver has to be connected to the AUX port.
- The R&S HL300 has to be connected to the AUX port.
- The R&S HE300 has to be connected to the power sensor connector.



GPS reference frequency

Note that the reference frequency is automatically adjusted as soon as the GPS receiver is enabled and a fix connection with enough satellites is established.

The "Instrument Setup" dialog box provides all settings necessary to configure the GPS receiver.

GPS	
GPS	Enabled
Show GPS Information	Enabled
Coordinate Format	ddd° mm' ss.sss"
GPS Receiver Connected	Yes
Position Fix	Invalid
Number of Tracked Satellites	0
Signal Quality	Insufficient

In addition, the R&S FSH shows some information about the GPS connection like the number of tracked satellites or the signal quality.

Enabling the GPS receiver

- ▶ In the "Instrument Setup" dialog box, select the "GPS Function" item.
- ▶ Press the ENTER key.

A dropdown menu to turn the GPS receiver on and off opens.



- ▶ Turn the GPS receiver on or off as required.
- ▶ Confirm the selection with the ENTER key.

When this feature is on, the R&S FSH is ready to receive GPS data.

Displaying GPS information

- ▶ In the "Instrument Setup" dialog box, select the "Show GPS Information" item.
- ▶ Press the ENTER key.

A dropdown menu to turn the display of the GPS coordinates on and off opens.



- ▶ Turn the display of GPS coordinates on or off as required.
- ▶ Confirm the selection with the ENTER key.

When this feature is on, and a sufficient connection to GPS satellites is established, the R&S FSH displays the GPS coordinates in a blue bar below the hardware information.

When the connection to a satellite is lost, the bar turns red and the GPS coordinates are shown in brackets. However, the R&S FSH still shows the last valid position.

The state of the satellite lock is shown in the title bar.

GPS in the title bar indicates that the GPS receiver is enabled and that there is a fix connection with enough satellites for the GPS receiver to provide the coordinates. The GPS information bar is blue.



[GPS] in the title bar indicates that the GPS receiver is enabled but that there is no fix connection to a satellite. The GPS information bar is red. The coordinates are not updated.



[GPS] in the title bar indicates that the GPS receiver is enabled, but that the receiver is not connected, not connected properly or defective. The GPS information bar is red. The coordinates are not updated.

The title bar shows no symbol, if the GPS receiver is not enabled.

If the GPS receiver is connected and enabled when you boot the R&S FSH, it asks whether to restore the GPS coordinates that were active just before it was shut down.

Selecting the coordinate format

- ▶ In the "Instrument Setup" dialog box, select the "Coordinate Format" item.
- ▶ Press the ENTER key.

A dropdown menu to select the coordinate format opens.



- ▶ Select the format you are most comfortable with from the dropdown menu.
- ▶ Confirm the selection with the ENTER key.

1.6.4 Configuring Date and Time

The R&S FSH has an internal clock that can apply a date and time stamp. In the "Instrument Setup" dialog box, you can set both date and time.

Date and Time	
Set Date	19/01/2012
Set Time	10:52:54
Time Zone	-01:00

Setting the date

- ▶ In the "Instrument Setup" dialog box, select the "Set Date" item.
- ▶ Press the ENTER key.

The R&S FSH asks you to confirm a change of the date.

! Warning !
Are you sure you want to change the 'Date' and not the 'Date Format'?
Press YES to continue, press NO to cancel

- ▶ Enter the date you want with the numeric keys. The sequence depends on the selected date format.

Set Date	14/06/2010
----------	------------

- ▶ Confirm the entry with the ENTER key.

Setting the time

- ▶ In the "Instrument Setup" dialog box, select the "Set Time" item.
- ▶ Press the ENTER key.
- ▶ Enter the time you want with the numeric keys.

Set Time	16:12:51
----------	----------

- ▶ Confirm the entry with the ENTER key.

After you have entered the time, the R&S FSH verifies the validity of the time. If it is not a valid time, it sets the next valid time.

Selecting the time zone

- ▶ In the "Instrument Setup" dialog box, select the "Time Zone" item.
- ▶ Press the ENTER key.
- ▶ Enter a positive or negative time offset relative to the system time with the numeric keys.

Time Zone	+01:00
-----------	--------

- ▶ Confirm the entry with the ENTER key.

After you have confirmed the time zone, the R&S FSH adjusts the displayed time accordingly, without changing the system time.

1.6.5 Selecting Regional Attributes

The regional settings allow you to select a different language, date format and length unit.

Regional	
Language	English
Date Format	dd/mm/yyyy
Length Unit	meter

Selecting the language

The R&S FSH provides several languages for the user interface.

- ▶ In the "Instrument Setup" dialog box, select the "Language" item.
- ▶ Press the ENTER key.

A dropdown menu opens to select the language.



- ▶ Select one of the languages from the dropdown menu.
- ▶ Confirm the selection with the ENTER key.

Setting the date format

The R&S FSH provides several formats to display the date as.

- ▶ In the "Instrument Setup" dialog box, select the "Date Format" item.
- ▶ Press the ENTER key.

A dropdown menu opens to select the date format.



- ▶ Select the date format you are most comfortable with from the dropdown menu.
- ▶ Confirm the selection with the ENTER key.

Setting the length unit

- ▶ In the "Instrument Setup" dialog box, select the "Length Unit" item.
- ▶ Press the ENTER key.

A dropdown menu opens to select the length unit.



- ▶ Select the length unit you are most comfortable with from the dropdown menu.
- ▶ Confirm the selection with the ENTER key.

1.6.6 Configuring the Display

The display settings configure display characteristics.

Display	
Display Backlight	50 %
Display Color Scheme	Color

The display of the R&S FSH is a TFT color LCD display.

Indoors, its ideal brightness depends on the intensity of the backlight. To strike a balance between battery operating time and screen display quality, set the backlight intensity to the minimum brightness needed.

To optimize the viewing angle, adjust the color settings. To achieve maximum contrast, the screen can be switched from color display to black-and-white display.

Under extreme light conditions, it can be of advantage to select the high-contrast monochrome display.

Adjusting the display backlight

- ▶ In the "Instrument Setup" dialog box, select the "Display Backlight" item.
- ▶ Press the ENTER key.
- ▶ Enter the backlight intensity you want with the numeric keys.



The backlight intensity is a percentage from 0% to 100% with 100% being the brightest.

- ▶ Confirm the entry with the ENTER key.

Selecting the display color scheme

- ▶ In the "Instrument Setup" dialog box, select the "Display Color Scheme" item.
- ▶ Press the ENTER key.

A dropdown menu opens to select the color scheme.



- ▶ Select the color scheme you want.
 - "Color" selects a color display.
 - "Black & White" selects monochrome display.
 - "Printer Friendly" inverts the colors.
- ▶ Confirm the selection with the ENTER key.

1.6.7 Configuring Audio Output

The audio settings control the audio output of the system.

Audio	
Key Click Volume	0 %
System Beeper Volume	30 %
Beep on Power Overload	Off

Setting the key click volume

The key click volume sets the volume of the sound that the R&S FSH produces when you press a key or softkey.

- ▶ In the "Instrument Setup" dialog box, select the "Key Click Volume" item.
- ▶ Press the ENTER key.
- ▶ Enter the volume you want with the numeric keys.



The key click volume is a percentage from 0% to 100% with 100% being the loudest.

- ▶ Confirm the entry with the ENTER key.

Setting the system beeper volume

The system beeper volume sets the volume of the system beeper of the R&S FSH, used for example if a message box pops up.

- ▶ In the "Instrument Setup" dialog box, select the "System Beeper Volume" item.
- ▶ Press the ENTER key.
- ▶ Enter the volume you want with the numeric keys.



The system beeper volume is a percentage from 0% to 100% with 100% being the loudest.

- ▶ Confirm the entry with the ENTER key.

Turning audio output in case of a power overload on and off

In case the R&S FSH detects an overload at one of its inputs, you can configure it to make a sound.

- ▶ In the "Instrument Setup" dialog box, select the "Beep on Power Overload" item.
- ▶ Press the ENTER key.



- ▶ Turn the beeper on or off.

When this feature is on, the R&S FSH will make a sound every time it detects an overload.

- ▶ Confirm the entry with the ENTER key.

1.6.8 Configuring Power Supply

The power settings contain settings that configure the power supply of the R&S FSH. The "Current Power Source" shows the source the R&S FSH is currently powered by. When you are using the battery to supply the R&S FSH with power, the remaining "Battery Level" is displayed as a percentage, with 100 % representing a full charge.

Power	
Current Power Source	Battery
Battery Level	59 %
Battery Low Level	20 %
Battery Low Level Beep	Off

Setting the battery low level

The battery low level is a reminder that the remaining battery charge might be used up soon.

When the battery low level is reached, the battery symbol in the title bar turns red and starts blinking.

- ▶ In the "Instrument Setup" dialog box, select the "Battery Low Level" item.
- ▶ Press the ENTER key.
- ▶ Enter the charge level in percent of a fully charged battery with the numeric keys.



- ▶ Confirm the entry with the ENTER key.

Turning audio output in case of battery low level state on and off

The R&S FSH also allows you to turn on an audio signal that indicates that the battery has reached its low level state.

- ▶ In the "Instrument Setup" dialog box, select the "Battery Low Level Beep" item.
- ▶ Press the ENTER key.



- ▶ Select either "Repetitive" or "Once" to turn the audio signal on.
 - If you have selected "Once", the R&S FSH will beep once if the battery runs out of power. For a continuous beep, select "Repetitive".
- ▶ Select "Off" to turn off the beeper.

1.6.9 Self Alignment

The self alignment calibrates the instrument settings for vector network analysis. During the self alignment, the R&S FSH generates new factory calibration data and overwrites the old factory calibration.

For the self alignment a short circuit (Short), an open circuit (Open) and a 50 Ohm match (Load) are required. In addition, a through connection must be established with an appropriate cable.

When you are in Network Analyzer mode, the "Calibration Kit" item becomes available and you can select the calibration kit that you want to use for the self alignment.

- ▶ In the "Instrument Setup" dialog box, select the "Calibration Kit" item.

The R&S FSH opens a dialog box to select a calibration kit.

- ▶ Select the required calibration kit.

Performing self alignment

- ▶ In the "Instrument Setup" dialog box, select the "Self Alignment" item.



- ▶ Press the ENTER key.

The R&S FSH initiates the self alignment procedure and shows a warning message box.

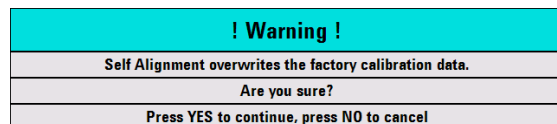

Selecting "Yes" initiates the self alignment procedure. Follow the instructions shown on the screen.

Selecting "No" cancels the self alignment procedure.

1.6.10 Using a PIN Code

The R&S FSH features a PIN protection system with several security levels that protects the R&S FSH from unauthorized access. When PIN protection is on, you have to enter the PIN whenever you turn the R&S FSH on.

For more information, please refer to the Operating Manual.

1.6.11 Resetting the R&S FSH

You can either preset the R&S FSH or reset it to factory settings.

Presetting the R&S FSH

The PRESET key resets the R&S FSH to the default setup of the currently active operating mode.

This allows you to define a new configuration based on defined measurement parameters without parameters from a previous measurement unintentionally still being active.

- ▶ Press the PRESET key.

Resetting the R&S FSH

A "Reset to Factory Settings" resets the R&S FSH to the factory defaults.

During a reset, the R&S ZVH restores the original configuration. It also deletes all customized datasets (limit lines, standards, channel tables, cable models etc.). Instead, it will reinstall all the datasets that have been available after delivery.

NOTICE

Risk of data loss

All datasets you have saved will be deleted during a factory reset.

- ▶ In the "Instrument Setup" dialog box, select the "Reset to Factory Settings" item.



- ▶ Press the ENTER key.

The R&S FSH initiates the reset procedure and shows a warning message box.

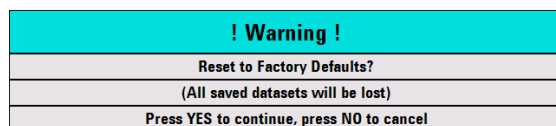

Selecting "Yes" performs the reset. During the reboot, it shows a corresponding message.

Selecting "No" cancels the reset.

1.7 Connecting the R&S FSH to a PC

The R&S FSH comes with the R&S FSH4View software package. This software package features several tools that allow you to document measurement results or create and edit limit lines or channel tables among other things.

Note that the .NET Framework 2.0 (or higher) is required on the PC to run the software properly.

You can set up a connection between the R&S FSH and R&S FSH4View either via its LAN port or its mini USB port.

You have to install the R&S FSH4View software on the PC before you are able to establish a connection.

- ▶ Run the CD-ROM delivered with the R&S FSH.
- ▶ Navigate to the "Software" section and start the setup file.
- ▶ Follow the instructions on the screen.

Alternatively, you can download the latest R&S FSH4View from the R&S FSH product homepage.



Firewall settings

If no connection can be established between the software and the R&S FSH after successful configuration, check the firewall settings on your PC.

1.7.1 Connecting the R&S FSH in a LAN

You can connect the R&S FSH directly to the PC with the LAN cable that is supplied with the R&S FSH. The LAN port is located on the left side of the R&S FSH behind a protective cap. For more information see "[Mini USB and LAN Ports](#)" on page 26.

You can set up the LAN connection in the "Instrument Settings" dialog box.

LAN Port	
MAC Address	00-90-b8-18-81-aa
DHCP	Off
IP Address	10.114.10.1
Subnet Mask	255.255.255.0
Gateway	0.0.0.0

For a direct connection between a PC and the R&S FSH, DHCP (Dynamic Host Configuration Protocol) has to be turned off (which is the default state).

- ▶ In the "Instrument Setup" dialog box, select the "DHCP" item.
- ▶ Press the ENTER key.

A dropdown menu to select the DHCP state opens.



- ▶ Turn DHCP on or off as required.

Setting an IP address and subnet mask

To establish a connection, the PC and the R&S FSH have to be in the same subnet.

- ▶ Identify the subnet mask of your PC, for example in the Microsoft Windows "TCP/IP Properties".

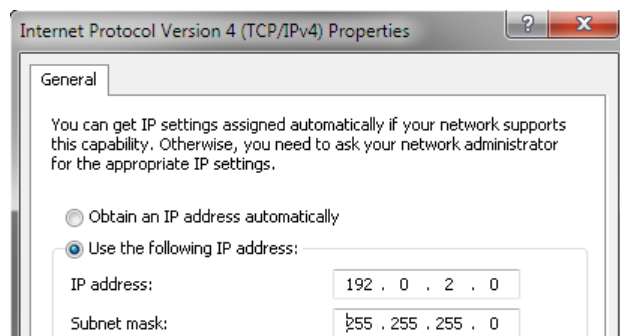

- ▶ In the "Instrument Setup" dialog box, select the "Subnet Mask" item.
- ▶ Press the ENTER key.
- ▶ Enter the subnet mask of the PC with the numeric keys.



- ▶ Confirm the entry with the ENTER key.

After you have matched the subnet mask, you can define the IP address. When both devices are in the same subnet, the first three digits of the IP address are usually the same ('192' in the example below).

Example

IP address PC	192.0.2.0
IP address R&S FSH	192.0.2.10

- ▶ Identify the IP address of your PC, for example in the Microsoft Windows "TCP/IP Properties".

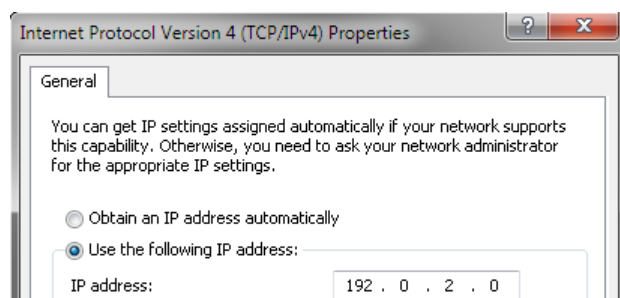

- ▶ In the "Instrument Setup" dialog box, select the "IP Address" item.
- ▶ Press the ENTER key.
- ▶ Enter the IP address of the PC with the numeric keys.



- ▶ Confirm the entry with the ENTER key.

Configuring the R&S FSH4View software

- ▶ Start R&S FSH4View.
- ▶ Select the "LAN" tab in the "Instrument Connect" dialog box.

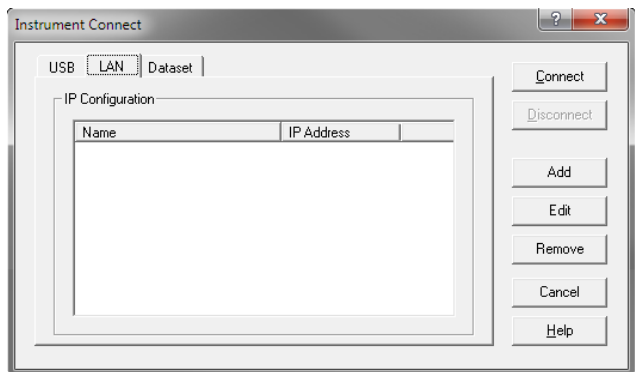

- ▶ Press the "Add" button to create a new network connection.

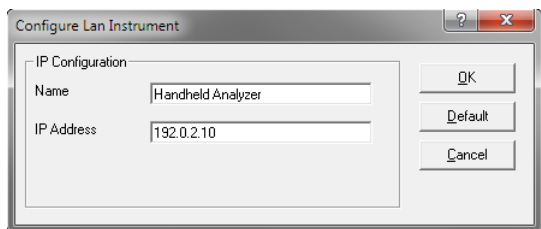

- ▶ Specify a name for the new network connection, for example R&S FSH.
- ▶ Enter the IP address for the R&S FSH (in this case 192.0.2.10)
- ▶ Confirm the entry with the "OK" button.

The connection is now created and configured and is added to the IP Configuration list.

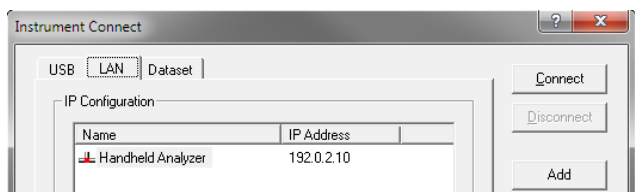

- ▶ Select the new connection labeled R&S FSH.
- ▶ Press the Connect button to establish the connection.

1.7.2 Connecting the R&S FSH in an existing LAN

You can either draw the R&S FSH IP address automatically from the DHCP server or manually assign a fixed address. With manual allocation, a fixed IP address and subnet mask must be assigned to the R&S FSH as described in the chapter on direct LAN connection. Then the R&S FSH4View software has to be configured as described with the assigned IP address.



Free IP address

Contact your IT system manager to get a free IP address.

In networks with a DHCP server, DHCP permits automatic allocation of the network configuration to the R&S FSH connected via LAN cable. For this purpose, DHCP has to be active on the R&S FSH.

DHCP is off by default. Turn it on like this:

- ▶ In the "Instrument Setup" dialog box, select the "DHCP" item.
- ▶ Press the ENTER key.

A dropdown menu to select the DHCP state opens.



- ▶ Select "On" to activate DHCP.

The R&S FSH is now allocated an IP address and the subnet mask by the DHCP server. This can take several seconds.

The IP address and subnet mask are automatically set in the corresponding input fields and are no longer available for editing.

Configure the R&S FSH4View software with the IP address and subnet mask as defined by the DHCP server. For more information see "[Connecting the R&S FSH in a LAN](#)" on page 46.

1.7.3 Connecting the R&S FSH via USB

Alternatively, you can connect the R&S FSH to the PC with the USB cable that is supplied with the delivery. The Mini USB interface is located on the left side of the R&S FSH behind a protective cap. For more information see "[Mini USB and LAN Ports](#)" on page 26.

When you connect the R&S FSH to a computer for the first time, Windows tries to install the new hardware automatically. The required drivers are installed along with the R&S FSH4View software package.

When the drivers have been found on your system and the hardware has been successfully installed, Windows shows a corresponding message.

- ▶ Connect the R&S FSH via the Mini USB port to your computer.
- ▶ Start R&S FSH4View on the PC.
- ▶ Select the "USB" tab in the "Instrument Connect" dialog box.

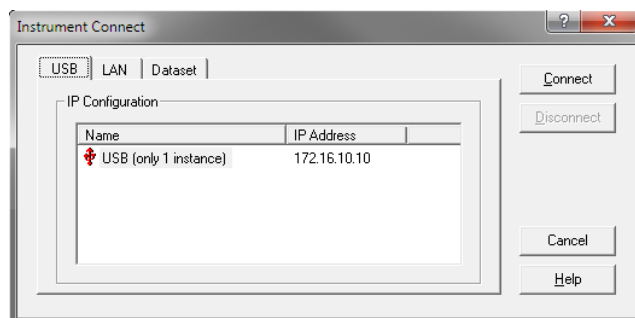

- ▶ Select the R&S FSH connection.
- ▶ Confirm the selection with the "Connect" button.



R&S FSH IP address

The R&S FSH internally emulates a LAN connection. The IP address displayed by R&S FSH4View for the USB connection is for information only. It is fixed to 172.16.10.10 and cannot be changed.

2 Getting Started

This chapter provides a short overview of several basic measurements you can perform with the R&S FSH.

Contents

- [Using the Spectrum Analyzer](#) (p. 52)
- [Using the Network Analyzer](#) (p. 59)
- [Using a Power Sensor](#) (p. 64)
- [Identifying Cable Faults](#) (p. 69)
- [Saving and Recalling Results and Settings](#) (p. 73)

2.1 Using the Spectrum Analyzer

This chapter provides a short overview of the first steps of the measurements you can perform with the R&S FSH.

2.1.1 Attenuating the Signal

You can attenuate the signal to a suitable level either manually or automatically.

In case of automatic attenuation, the level of attenuation at the RF input depends on the current reference level. The R&S FSH provides two ways of automatic attenuation.

For the highest possible sensitivity it provides the "Auto Low Noise" attenuation mode. For the lowest possible intermodulation, it provides the "Auto Low Distortion" mode.

The main difference between the two modes is that the attenuation level is 5 to 10 dB higher in case of "Auto Low Distortion" than it is for "Auto Low Noise". In the default state, "Auto Low Distortion" is active.

- ▶ Press the AMPT key.
- ▶ Press the "RF Att/Amp/Imp" softkey.
- ▶ Select either the "Auto Low Noise" or "Auto Low Distortion" menu item.

The R&S FSH shows the current attenuation level in the hardware settings overview ("Att.:" caption). The currently active menu item has a green background.

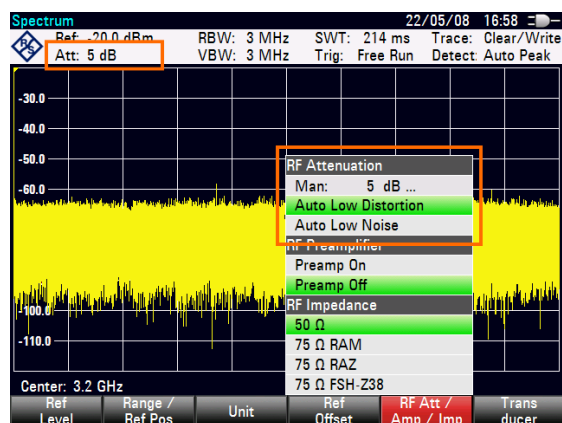

You can also set the attenuation manually. The R&S FSH provides attenuation in the range from 0 to 40 dB in 5 dB steps.

- ▶ Press the AMPT key.
- ▶ Press the "RF Att/Amp/Imp" softkey.
- ▶ Select either the "Man: 0 dB" menu item.

The R&S FSH opens an input field to define the attenuation.

The R&S FSH provides several methods to fill in input fields:

- directly with the number keys
- with the rotary knob
- with the cursor keys

While you can enter any number you want with the number keys, using the rotary knob or the cursor keys is coupled to a certain step size in most cases.

If you use the rotary knob to change the attenuation, for example, the step size is 5 dB.

- ▶ Enter the attenuation you need.

Again, the R&S FSH shows the current attenuation level in the hardware settings overview ("Att.:" caption).

2.1.2 Using the Preamplifier

The R&S FSH has an internal preamplifier to increase sensitivity. Depending on the frequency, the gain of the amplifier is in the range from 15 to 20 dB and increases the sensitivity by 10 to 15 dB.

In the signal path, the preamplifier comes after the RF attenuator and before the input mixer.

- ▶ Press the AMPT key.
- ▶ Press the "RF Att/Amp/Imp" softkey.
- ▶ Select either the "Preamp On" or "Preamp Off" menu item.

The R&S FSH turns the preamplifier on or off.

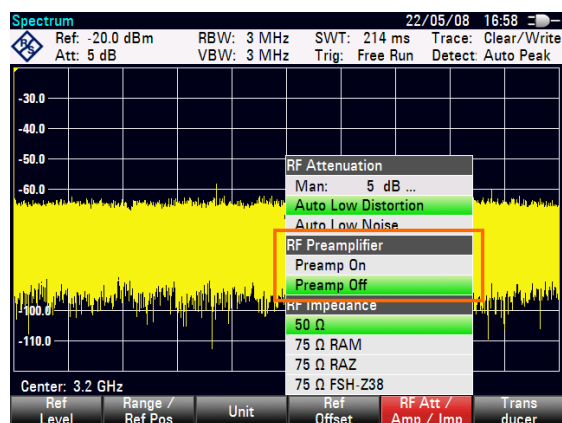

The magnitude of amplification depends on the reference level. This coupling to the reference level makes sure that the dynamic range is at an optimum.

2.1.3 Measuring CW Signals

A basic task for spectrum analyzers is to measure the level and frequency of sinewave signals. The following examples illustrate an effective way of performing these measurements.

A signal generator, e.g. R&S SMBV provides the signal source.

Test setup

Connect the RF output of the signal generator to the RF input of the R&S FSH.

Signal generator settings:

Frequency: 700 MHz

Level: -30 dBm

Measuring the level

- ▶ Press the PRESET key.

The R&S FSH is reset to its default state.

After the preset, the R&S FSH displays the frequency spectrum over its full frequency span. At 700 MHz, the generator signal is displayed as a vertical line.

To analyze the generator signal at 700 MHz in more detail, reduce the frequency span.

- ▶ Press the FREQ key.

The R&S FSH opens an input field to enter the center frequency.

- ▶ Enter a center frequency of 700 MHz.

The signal is now in the center of the display.

- ▶ Press the SPAN key.

The R&S FSH opens an input field to specify the span.

- ▶ Enter a span of 10 MHz.

The R&S FSH now displays the generator signal with a higher resolution.

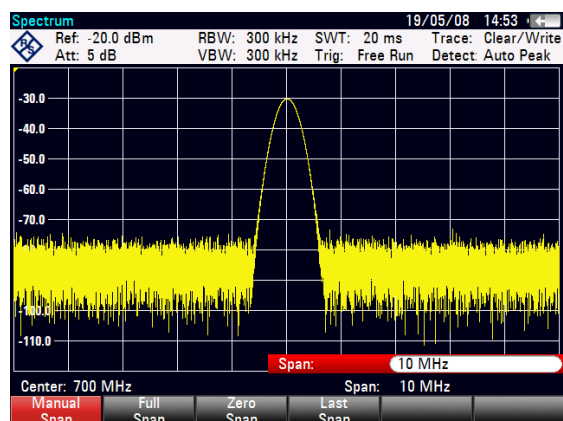

Setting the reference level

The level at the top of the measurement diagram is called the reference level. To obtain the best dynamic range from the R&S FSH, you should use its full level range. That means that the maximum level value should be at or close to the top of the measurement diagram (= reference level).

- ▶ Press the AMPT key.
- ▶ Press the "Ref Level" softkey.
- ▶ Enter a reference level of -30 dBm.

The R&S FSH reduces the reference level by 10 dB.

The maximum trace value is close to the maximum scale value of the measurement diagram. The increase in the displayed noise floor is minimal. The difference between the signal maximum and the displayed noise (i.e. the dynamic range) has, however, been increased.

Using Markers

The R&S FSH has markers to read out signal levels and frequencies. Markers are always positioned on the trace. Both the level and frequency at their current positions are displayed on the screen.

- ▶ Press the MARKER key.

The R&S FSH activates a marker and puts it on the maximum value on the trace.

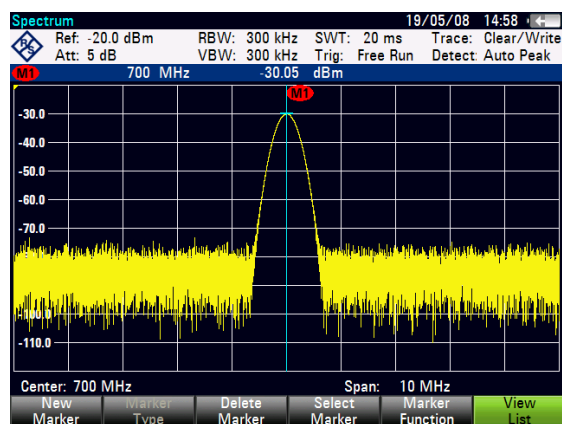

A blue vertical line represents the position of the marker on the horizontal axis (e.g. the frequency).

A small blue horizontal dash represents the marker position on the vertical axis (e.g. the level).

The R&S FSH shows the coordinates of all markers in a table above the diagram.

Measuring the frequency

The trace consists of 631 measurement points (frequency points). The marker is always positioned on one of these measurement points. The R&S FSH calculates the marker frequency from the frequency of the measurement point, the center frequency and the frequency span that have been set. The measurement-point resolution, and consequently the accuracy of the marker frequency readout, therefore depend on the frequency span that has been selected.

The R&S FSH has a frequency counter to increase the accuracy of the marker-frequency readout. It stops the sweep at the marker position, counts the frequency and then continues the sweep.

- ▶ Press the MARKER key.
- ▶ Press the "Marker Function" softkey.
- ▶ Select the "Frequency Count" menu item.

The marker label "M" turns to a "C" to indicate an active frequency counter. When the frequency counter is active, the resolution of the frequency readout is always 1 Hz, regardless of the span. The accuracy is determined by the internal reference frequency which is far more exact than that of the pixel-oriented marker readout.

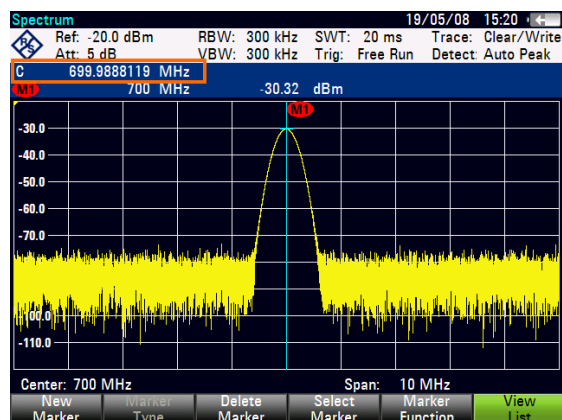

2.1.4 Measuring Harmonics

A spectrum analyzer is ideal to measure harmonic levels or harmonic ratios, because it can resolve different signals in the frequency domain.

With marker functions, you can speed up measurement tasks like that.

A signal generator, e.g. R&S SMBV provides the signal source.

Test setup

Connect the RF output of the signal generator to the RF input of the R&S FSH.

Signal generator settings:

Frequency: 100 MHz

Level: -20 dBm

Detecting harmonics

- ▶ Press the PRESET key.

The R&S FSH is reset to its default state.

After the preset, the R&S FSH displays the frequency spectrum over its full frequency span. At 700 MHz, the generator signal is displayed as a vertical line.

In addition you can see the harmonics as smaller vertical lines at frequencies that are multiples of 100 MHz.

To measure the second harmonic ratio, decrease the span.

- ▶ Press the FREQ key.
- ▶ Press the "Start Freq" softkey.
- ▶ Enter a start frequency of 50 MHz
- ▶ Press the "Stop Freq" softkey.
- ▶ Enter a stop frequency of 250 MHz.

The R&S FSH displays the frequency spectrum in the range from 50 MHz to 250 MHz. This frequency range visualizes the signal itself at 100 MHz and the second harmonic at 200 MHz.

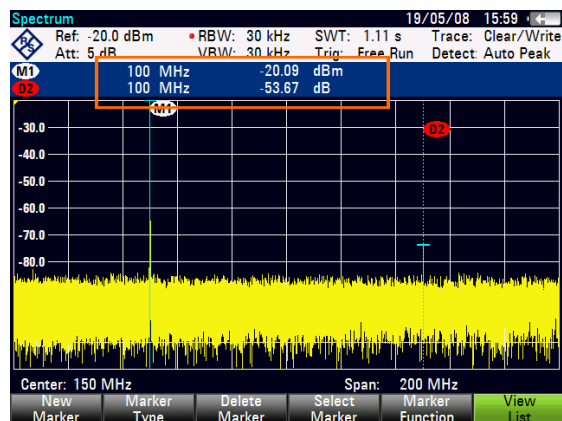

To measure the harmonic ratio, set the marker on the signal and a delta marker on the second harmonic.

- ▶ Press the MARKER key.

The R&S FSH sets a marker on the trace maximum. The trace maximum corresponds to the signal.

- ▶ Press the "New Marker" softkey.

The R&S FSH activates a delta marker and places it on the next trace maximum. This corresponds to the second harmonic.

The harmonic ratio is the vertical distance of the marker and the delta marker. The R&S FSH displays this value in the marker table (see picture above).

2.2 Using the Network Analyzer

R&S FSH models that feature a tracking generator can do two-port measurements like measuring the gain or attenuation of devices under test.

The tracking generator generates a sine signal at the receive frequency of the R&S FSH.

The R&S FSH provides scalar measurements with the basic configuration. To be able to perform vector measurements you can equip the R&S FSH with firmware option R&S FSH-K42 (order no. 1304.5629.02).

If the R&S FSH also has a VSWR bridge, you are able to perform reflection measurements in addition to transmission measurements.

Test setup

Connect the device under test (DUT) to the R&S FSH.

For measurements on devices that require an external voltage (like power amplifiers), connect the supply of a voltage from a suitable AC power supply to one of the BIAS ports (R&S FSH with VSWR bridge only).

- ▶ Press the MODE key.
- ▶ Press the "Network Analyzer" softkey.

The R&S FSH turns on the tracking generator and starts the network analyzer mode.

To get the most accurate results, you should calibrate the R&S FSH for the measurement.

In its default state, the R&S FSH is factory calibrated. Factory calibration is a full 2-port calibration over the complete frequency range. The status line reads **(fcal)**.

You will get sufficiently accurate measurement results with factory calibration, but if you add a cable between the DUT and the test port, it is recommended to calibrate again and take the cable characteristics into account this way.

Before starting the calibration, you should set the frequency and span because calibration is valid only for the calibrated frequency and span.

- ▶ Press the FREQ key.
- ▶ Enter the required center frequency.
- ▶ Press the SPAN key.
- ▶ Enter the required span.

2.2.1 Calibrating the R&S FSH

Depending on the measurement mode, the R&S FSH provides several calibration methods.

Basically, the procedure during calibration is the same for all calibration methods and measurement modes in that you need to connect one or more calibration standards to the port(s) of the R&S FSH.

Accessories like the R&S FSH-Z28 or -Z29 calibration kit (order no. 1300.7810.03 and 1300.7510.03) already provide a combined "Open", "Short" and "Load".

To calibrate (directional) transmission measurements you will also need a "Through" connection.

This chapter shows a calibration procedure for a vector return loss measurement on port 1 as an example. For this calibration method the "Open", "Short" and "Load" standards are necessary.

- ▶ Press the MEAS key.
- ▶ Press the "Meas Mode" softkey.
- ▶ Select the "Vector" menu item.

The R&S FSH starts vector measurements.

- ▶ Press the "Calibration" softkey.
- ▶ Select the "Reflection Port 1" menu item.

The R&S FSH asks you to terminate port 1 into an open circuit ("Open").

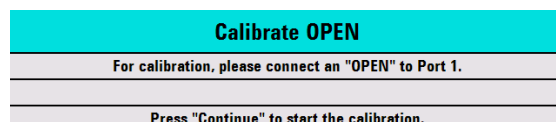

- ▶ Connect the "Open" to port 1.
- ▶ Press the "Continue" softkey.

The R&S FSH calibrates the open circuit.

Next, the R&S FSH asks you to terminate port 1 into a short circuit ("Short").

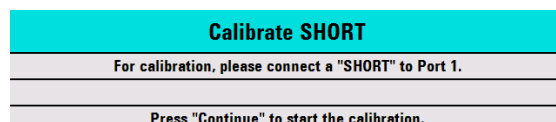

- ▶ Connect the "Short" to port 1.
- ▶ Press the "Continue" softkey.

The R&S FSH calibrates the short circuit.

Last, the R&S FSH asks you to terminate port 1 into a 50 Ω termination ("Load").

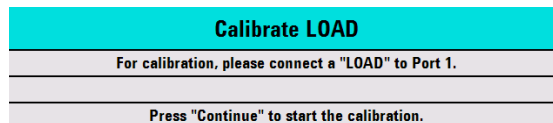

- ▶ Connect the "Load" to port 1.
- ▶ Press the "Continue" softkey.

When the calibration is finished, the R&S FSH shows the message **Calibration done!**. The status line now says **(cal)**.

If you have calibrated a scalar measurement, the status line says **(norm)**, because only normalization is available for scalar measurements.

Quality of calibration deteriorates if you change either frequency parameters (center, start or stop frequency and span), attenuation or tracking generator power.

After changing attenuation or tracking generator power, the calibration is still valid, but probably more inaccurate. The R&S FSH shows that by adding a '?' to the status line (e.g. **(cal?)**).

Calibration also remains valid if you change one of the frequency settings inside the calibrated frequency range. However, results also may be more inaccurate. In that case, the R&S FSH interpolates the correction data between the reference points of the calibration before applying them to the measurement. The label in the status line reads **(interp)**.

If you change one of the frequency settings to a value that is outside the calibrated frequency range, the R&S FSH gets uncalibrated and will use factory calibration instead. The status line reads **(fcal)**.



2-Port Calibration

With a two-port calibration it is possible to measure the forward and reverse direction without a new calibration.

If you change one of the parameters that interfere with the calibration by accident, you can restore the last calibration settings.

- ▶ Press the MEAS key.
- ▶ Press the "Calibration" softkey.
- ▶ Select the "Restore Calibration Settings" menu item.

The R&S FSH restores all settings (including span and frequency) that were active during the last calibration.

Note that calibration data is included in data sets. Therefore it is possible to start a measurement without performing calibration after loading a data set.

For an extensive description of available calibration methods and states see the operating manual.

2.2.2 Measuring the Vector Reflection

To perform vector measurements you have to equip the R&S FSH with firmware application R&S FSH-K42.

Reflection measurements are available for all R&S FSH models with a tracking generator and VSWR bridge.

With a model that features a VSWR bridge, you can perform the measurement at both ports. For models without a VSWR bridge reflection measurement are possible only on port 1.

- ▶ Press the MEAS key.
- ▶ Press the "Meas Mode" softkey.
- ▶ Select the "Vector" menu item.

The R&S FSH starts vector measurements.

- ▶ Press the FREQ key.
- ▶ Enter the frequency of the DUT.
- ▶ Press the SPAN key.
- ▶ Enter an appropriate span.

As you have changed the frequency settings, you should calibrate the R&S FSH for more accurate results.

- ▶ Calibrate the R&S FSH for vector reflection measurements at the port you want (see above).
- ▶ Reconnect the DUT.

The R&S FSH shows the magnitude of the reflection.

To evaluate the results, you can use, for example, markers. To get different aspects of the results, you can use several measurement formats, like the phase or the reflection coefficient.

- ▶ Press the "Meas Format" softkey.
- ▶ Select the format you would like to see.

The R&S FSH adjusts the display accordingly. The current measurement format is always displayed in the status line.

2.2.3 Measuring Scalar Transmission

Scalar measurements are available for all R&S FSH models with a tracking generator.

- ▶ Connect the DUT between the RF input and the tracking generator output.

Note that you need an R&S FSH with VSWR bridge to be able to measure the transmission in forward and reverse direction. Models without VSWR bridge can measure the transmission in reverse direction only.

- ▶ Press the MEAS key.
- ▶ Press the "Meas Mode" softkey.
- ▶ Select the "Scalar" menu item.

The R&S FSH starts scalar measurements.

- ▶ Press the FREQ key.
- ▶ Enter the frequency of the DUT.
- ▶ Press the SPAN key.
- ▶ Enter an appropriate span.

As you have changed the frequency settings, you should calibrate the R&S FSH for more accurate results.

- ▶ Calibrate (normalize) the R&S FSH for scalar transmission measurements in the direction you want (see above).
- ▶ Reconnect the DUT.

The R&S FSH shows the magnitude of the transmission.

To evaluate the results, you can use, for example, markers.



2.3 Using a Power Sensor

For highly accurate power measurements, you can connect one of the power sensors that are supported by the R&S FSH.

The power sensors R&S FSH-Z1 and -Z18 are especially designed for use with the R&S FSH.

You can connect the power sensors available for the R&S FSH to the RS-232-C interface on the top face of the R&S FSH. This connector allows you to control the power sensor and supplies it with power.

It is also possible to use one of the R&S NRP power sensors. When you use one of these, connect it to the USB interface on the right side of the R&S FSH.

Note that only R&S FSH models with a 20 MHz bandwidth (serial numbers 105000 and higher) have an USB port.

2.3.1 Measuring the Power with a Power Sensor

The power sensors R&S FSH-Z1 and R&S FSH-Z18 measure the power in the range from 10 MHz to 8 GHz and 18 GHz respectively.

For more information about the characteristics of the R&S NRP power sensors, refer to their datasheets.

NOTICE

Risk of damaging the power sensor

Because of high input power,

- the continuous power applied to the power sensor's input must not exceed 400 mW (26 dBm)
- use an attenuator for measurements on highpower transmitters

However, brief power peaks $\leq 10 \mu\text{s}$ up to 1 W (30 dBm) are permissible.

Test setup

Connect the cable of the power sensor to the power sensor jack of the R&S FSH.

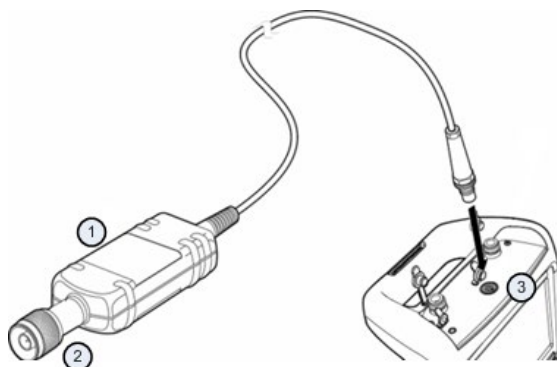

- 1 Power sensor R&S FSH-Z1 or R&S FSH-Z18
- 2 Power sensor connector (DUT)
- 3 Power sensor jack

Measuring the power

- ▶ Press the MODE key.
- ▶ Press the "Power Meter" softkey.

The R&S FSH switches its operating mode.

If the R&S FSH recognizes a power sensor, it sets up a connection via the interface and after a few seconds shows the measured power.

If no power sensor has been connected or is not connected appropriately, the R&S FSH shows nothing.

If there are communication problems between the R&S FSH and the power sensor, the R&S FSH displays an error message that indicates a possible cause. For more information see the operating manual.

Zeroing the power sensor

To compensate internal offsets of the power meter, it needs to be compensated for before starting the measurement.

- ▶ Press the "Zero" softkey.

The R&S FSH asks you not to apply any signals to the power sensor while zeroing is active.

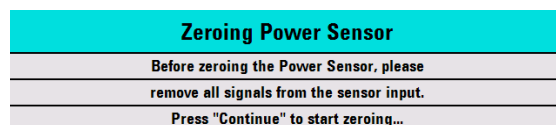

- ▶ Disconnect the power sensor from any signal sources.
- ▶ Press the "Continue" softkey to start zeroing.

The R&S FSH starts the zeroing process. It asks you to wait until it is finished.

After zeroing is done, the R&S FSH outputs the message "Power Sensor Zero OK" and again shows the power sensor softkey menu.

- ▶ Connect the signal under test to the power sensor.

The R&S FSH shows the measured power level in dBm.

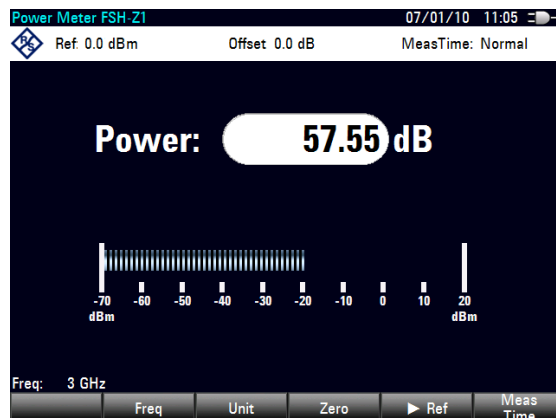

Entering the frequency

To get the best results, also enter the frequency of the signal under test.

- ▶ Press the "Freq" softkey.
- ▶ Enter the frequency of the signal.
- ▶ Confirm the entry with one of the unit keys.

The R&S FSH transfers the new frequency to the power sensor which then corrects the measured power readings.

2.3.2 Measuring Power and Return Loss

With the directional power sensors R&S FSH-Z14 and R&S ZVH-Z44 you can measure the power in both directions.

When you connect the directional power sensor between the source and the load, the R&S FSH measures the power from source to load (forward power) and from load to source (reverse power).

The ratio between forward and reverse power is a measure of the load matching. The R&S FSH displays it as the return loss or standing wave ratio.

The power sensors for the R&S FSH have an asymmetrical design. Therefore, they have to be inserted into the test setup in such a way that the "Forward" arrow on the sensor points toward the load (= in the direction of the power flux).

When measuring high powers, pay strict attention to the following instructions to avoid personal injury and to prevent the power sensor from being destroyed.

⚠ CAUTION

Danger of skin burns and damage to the instrument

- Never exceed the permissible continuous power.
- See diagram on the rear of the sensor for the permissible continuous power.
- Turn off the RF power to connect the sensor.
- Screw the RF connectors tightly..

Test setup

Connect the cable of the power sensor to the power sensor jack of the R&S FSH and insert the directional power sensor between the source and the load.

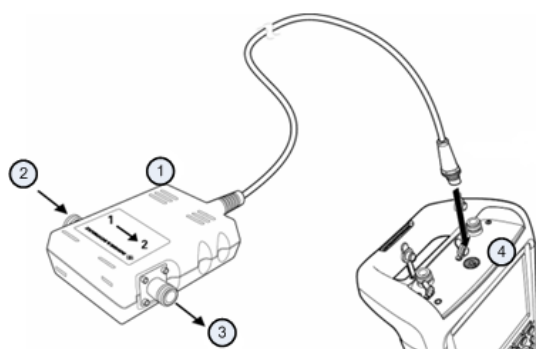

- 1 Directional power sensor R&S FSH-Z14 or Z44
- 2 Source
- 3 Load
- 4 Power sensor jack

Measuring the power

- ▶ Press the MODE key.
- ▶ Press the "Power Meter" softkey.

As soon as the R&S FSH recognizes the power sensor, it shows the type of the directional power sensor that is connected in the diagram header. After a few seconds it also shows the forward power and return loss currently measured at the load.

Zeroing the power sensor

Before performing the power measurement, you should zero the power sensor. For more information, see "[Measuring the Power with a Power Sensor](#)" on page 65.

After zeroing is done, the R&S FSH outputs the message "Power Sensor Zero OK" and again shows the power sensor softkey menu.

- ▶ Connect the R&S FSH-Z14 or R&S FSH-Z44 between the source and the load.
The R&S FSH displays the measured forward power in dBm and the SWR of the load.

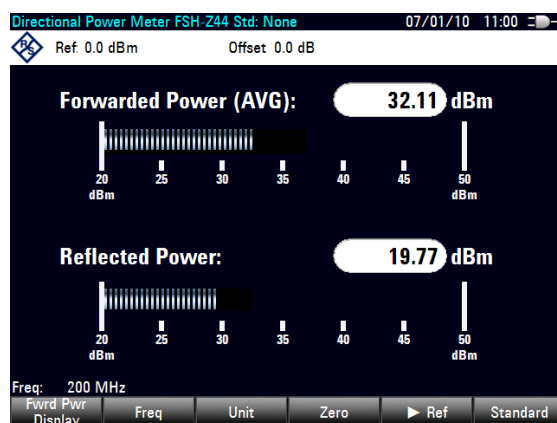

To get the best results, you should also define the frequency of the signal. For more information see "[Measuring the Power with a Power Sensor](#)" on page 65.

2.4 Identifying Cable Faults

The R&S FSH can perform cable measurements if it features a tracking generator and VSWR bridge. You also have to equip it with firmware option R&S FSH-K41 (DTF measurements, order no. 1304.5612.02).

Test setup

The test setup requires an R&S FSH, an RF cable (for example R&S FSH-Z320) and a calibration standard (for example R&S FSH-Z28 or R&S FSH-Z29).

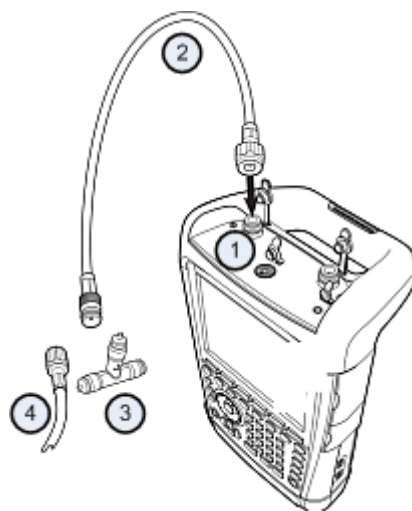

- | | |
|---|----------------------|
| 1 | RF input (port 1) |
| 2 | RF cable |
| 3 | Calibration standard |
| 4 | Test cable (DUT) |

- ▶ For measurements on DUTs that require an external voltage supply (for example power amplifiers), connect the supply voltage from a suitable AC power supply to the BIAS PORT 1 input.
- ▶ Connect the RF test cable to the RF input of the R&S FSH.



You should use the RF cable. Otherwise, measurement results may be invalid.

Starting the measurement

- ▶ Press the MODE key.
- ▶ Press the "Distance-to-Fault" softkey.

The R&S FSH starts the distance-to-fault measurement.

Selecting the measurement port

In the default state, port 1 (RF input) already is the measurement port.

To select the measurement port manually,

- ▶ Press the MEAS key.
- ▶ Press the "Meas Mode" softkey.
- ▶ Select the "DTF / Refl Measurement Port" menu item.
- ▶ Select the port you want to perform the measurement on.

Setting the frequency

To get the best results, you should adjust the center frequency to that of the DUT.

- ▶ Press the FREQ key.
- ▶ Press the "DTF Center Freq" softkey.
- ▶ Enter the center frequency you need (for example that of the antenna at the other end of the cable) with the numeric keys.

The R&S FSH automatically calculates the best bandwidth for the current measurement.

Specifying the cable model

To perform cable tests, you have to specify the type of the cable and its approximate length.

- ▶ Press the MEAS key.
- ▶ Press the "Cable Config" softkey.
- ▶ Select the "Select Cable Model..." item.

The R&S FSH opens a dialog box to select the cable model.



- ▶ Select the cable model that you need from the list of cables.
- ▶ Confirm the selection with the "Select" softkey.

The currently active cable model is always shown in the display header.

You can also define new cable models on the R&S FSH or with the R&S FSH4View software and then transfer them to the R&S FSH. For more information see the operating manual.

In addition to the cable model, you should also specify the length of the cable.

- ▶ Press the "Cable Config" softkey.
- ▶ Select the "Cable Length" item.

The R&S FSH opens an input field to specify the cable length. The range is from 3 m (10 ft) to 1500 m (4921 ft).

- ▶ Enter the cable length.

The unit depends on the regional settings. It is either meter or feet. For more information see "[Selecting Regional Attributes](#)" on page 40.

The R&S FSH uses the cable length to determine the ideal span for the measurement and to scale the horizontal axis. For best results, the cable should be specified 20% to 50% longer than the actual cable length.

Calibrating the test setup

Before connecting the cable, you should calibrate the R&S FSH to get the best measurement results.

- ▶ Press the MEAS key.
- ▶ Press the "Calibration" softkey.
- ▶ Select the "Calibrate" menu item.

The R&S FSH asks you to connect a "Short", an "Open" and a "Load" to the measurement cable.

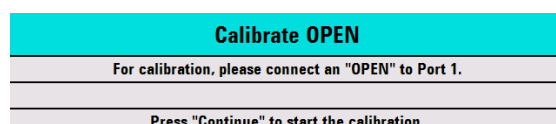

- ▶ Firmly connect the short, the open and the load to the output end of the cable.
- ▶ After each step, proceed with the "Continue" softkey.

After the calibration, the R&S FSH shows that it is calibrated by displaying (CAL).

- ▶ Screw the cable under test back to the measurement cable.



In DTF mode, the R&S FSH performs calibration over its entire span. Therefore, you do not have to perform a new calibration after changing the frequency range or cable length.

The R&S FSH stores the calibration data in its memory. Thus, the calibration is valid after you change the operating mode or after you turn off the R&S FSH.

The R&S FSH now shows the cable characteristics over the cable's entire length. With a marker, you can easily detect the distance to the cable fault.

In addition to the distance to fault measurement, the R&S FSH also features a cable spectrum measurement and a reflection measurement, for example to test impedance matching.

Using markers

The R&S FSH has markers to read out signal levels and frequencies. Markers are always positioned on the trace. Both the level and frequency at their current positions are displayed on the screen.

- ▶ Press the MARKER key.

The R&S FSH activates a marker and puts it on the maximum value on the trace.

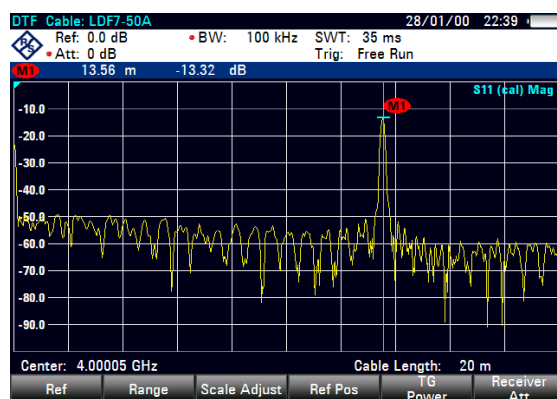

A blue vertical line represents the position of the marker on the horizontal axis (e.g. the frequency).

A small blue horizontal dash represents the marker position on the vertical axis (e.g. the level).

The R&S FSH shows the coordinates of all markers in a table above the diagram.

2.5 Saving and Recalling Results and Settings

The R&S FSH can store measurement results and settings in the internal memory, on a removable SD memory card or on a memory stick via the USB interface.

Results and settings are always stored together, allowing them to be interpreted in context when recalled. The R&S FSH can store at least 100 data records in the internal memory which are differentiated by their names.

The R&S FSH provides a USB port and a SD card slot. For more information see "[USB Port](#)" and "[SD Card Slot](#)".

To use the SD card, insert it into the slot until it audibly clicks into place. Remove the SD card, by pressing it in and then pulling it out.

2.5.1 Saving Measurement Results

- ▶ Press the SAVE/RECALL key.
- ▶ Press the "Save" softkey.

The R&S FSH opens the file manager dialog box.



- 1 Available data sets and folder structure
- 2 Data set name input field
- 3 Remaining memory on selected data storage
- 4 File manager softkey menu

- ▶ Specify a name for the data set in the input field of the dialog box with the number keys.

In addition, ▼ moves the cursor to the left, ▲ moves it to the right and the BACK key deletes a character.

You can either

- overwrite a data set that already exists by selecting it from the available data sets with the cursor keys or
 - edit the name of an existing data set with the cursor keys and the numeric keys or
 - create a new data set by entering a new name with the numeric keys.
- ▶ Select the storage medium you want to use.
 - ▶ Press the "Save" softkey.

The R&S FSH saves the data set.

2.5.2 Recalling Measurement Results

Use the R&S FSH recall function to review previously saved measurement results and settings.

- ▶ Press the SAVE/RECALL key.
- ▶ Press the "Recall" softkey.

A list of all saved data sets opens.

If you want to recall results from the SD card or a USB stick, select it first to view its contents.

Select a data set from the list with the cursor keys.

- ▶ Confirm your selection with the "Recall" softkey.

Index

AC adapter	15	Headphone jack.....	23
Accessories	12	IF output	25
Accessory detection.....	32	Kensington lock	26
Attenuation	52	LAN port	26
Audio settings	42	Languages.....	40
Auto low distortion	52	Length unit.....	40
Auto low noise	52	Options	28
AUX input	23, 37	Positioning.....	14
Backlight.....	41	Power overload beep.....	42
Battery (car adapter).....	16	Power sensor.....	65
Battery (charging)	16	directional.....	67
Battery (external charger)	17	Power sensor port.....	22
Battery (replacement)	16	Power settings	43
Battery insertion.....	14	Preamplifier	53
Battery low level.....	43	Preset.....	45
BIAS ports	24	Regional settings	40
BNC connectors.....	24	Reset.....	45
configuration.....	32	RF input.....	21
Color scheme.....	41	SD card slot.....	27
Connectors	20	Self alignment.....	44
Controls	13	Signal attenuation	52
Date & time.....	39	Spectrum analyzer	52
Date format.....	40	Support.....	14
DC port	27	Tracking generator output.....	22
Directional power sensor.....	67	USB port.....	26, 27
Display settings.....	41	User Interface.....	13
External reference	24	Volume	
External trigger	24	key click volume	42
GPS information	38	system beeper.....	42
GPS receiver	37	Zeroing	66, 68
Hardware settings.....	32	ZVHView	46